



qubino®

Your little magic for the smartest home.

USER MANUAL **EN**

QUBINO FLUSH 2 RELAY

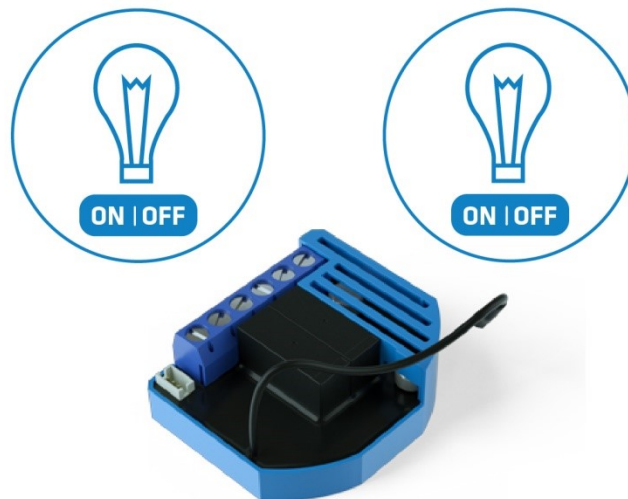

The Qubino Flush 2 Relay is ideal for remotely controlling up to two electrical devices (door locks, door openers, small appliances, etc.) or lights.

Table of contents

- About Qubino3
- Safety Information.....5
- Flush 2 Relay - Available Frequencies6
- Where To Buy7
- 1. Introduction7
- 2. Use Cases9
 - 2.1. Installation examples where Flush 2 Relay is installed behind a wall switch9
 - 2.2. Installation examples where Flush 2 Relay is installed in electrical box10
 - 2.3. Additional features of Flush 2 Relay which can make your life easier11
- 3. Qubino Flush 2 Relay Advantages and Highlights.....13
 - 3.1. Advantages13
 - 3.2. Highlights16
- 4. Package Contents17
- 5. Technical Terms for Switches18
- 6. Compatibility with Z-Wave Gateways (hubs)20
- 7. Installation21
 - 7.1. Installing the device behind a light switch22
 - 7.2. Installing the Qubino Temperature Sensor33
- 8. Device Information and Support38
- 9. Electrical Diagram (110 – 240VAC, 24VDC)39
- 10. Adding the device to a Z-Wave network (Inclusion).....40
- 11. Removing the device from a Z-Wave network (Exclusion)41
- 12. Associations42
- 13. Configuration Parameters43
- 14. Technical Specifications52
- 15. Z-Wave Command Classes54
- 16. Important Disclaimer58
- 17. Warning58
- 18. Regulations58

About Z-Wave:

The Z-Wave protocol is an interoperable, wireless, RF-based communications technology designed specifically for control, monitoring, and status reading applications in residential and light commercial environments. Mature, proven, and broadly deployed (with over 50 million products sold worldwide), Z-Wave is by far the world market leader in wireless control, bringing affordable, reliable, and easy-to-use 'smart' products to millions of people in every aspect of daily life.

Source: www.z-wavealliance.org

Safety Information

For Qubino, safety is first, so we have prepared lots of safety tips and information that can be found throughout this manual.

To ensure your safety, please read this manual carefully before installing the device; follow the instructions exactly. The manufacturer (GOAP d.o.o. Nova Gorica) shall not be legally responsible for any equipment damage or personal injury caused by incorrect installation or operation other than that covered in this manual.

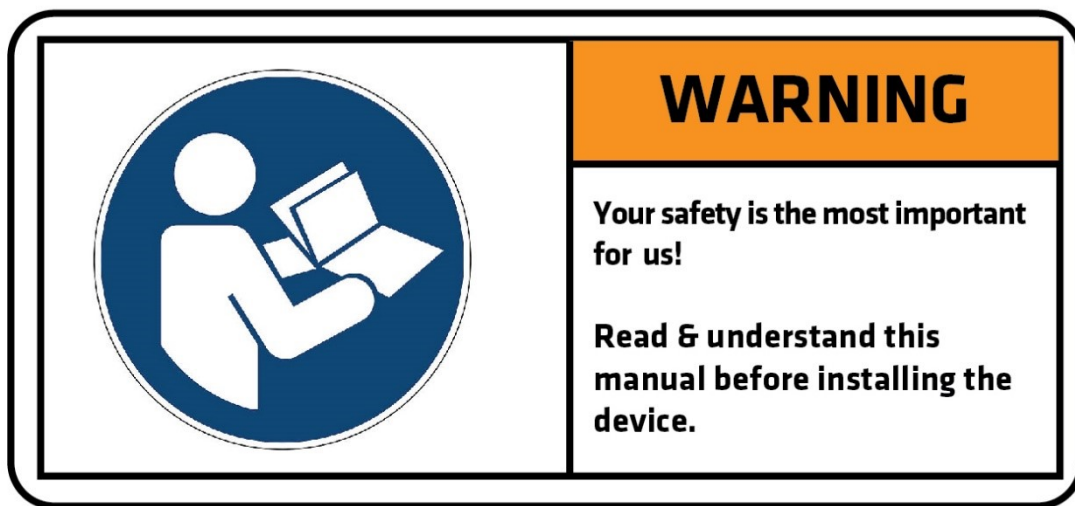

i Please check the Technical Specifications and Electrical Diagram chapters, as well as fuse requirements in the Installation chapter before installing the device.

Flush 2 Relay - Available Frequencies

ORDERING CODE (MODEL NUMBER)	POWER SUPPLY FREQUENCY	Z-WAVE FREQUENCY*
ZMNHBD1	50/60 Hz	868,4 MHz
ZMNHBD2	50/60 Hz	921,4 MHz
ZMNHBD3	50/60 Hz	908,4 MHz
ZMNHBD4	50/60 Hz	869,0 MHz
ZMNHBD5	50/60 Hz	916,0 MHz
ZMNHBD6	50/60 Hz	868,4 MHz
ZMNHBD7	50/60 Hz	919,8 MHz
ZMNHBD8	50/60 Hz	865,2 MHz
ZMNHBD9	50/60 Hz	922,5 MHz
ZMNHBD A	50/60 Hz	919,7 – 921,7 – 923,7 MHz
ZMNHBD B	50/60 Hz	868,1 MHz
ZMNHBD C	50/60 Hz	868,1 MHz
ZMNHBD D	50/60 Hz	919,8 MHz
ZMNHBD E	50/60 Hz	920,9 MHz

*You can check the Z-Wave frequency in your country here:

<https://www.silabs.com/products/wireless/mesh-networking/z-wave/benefits/technology/global-regions?cid=nat-acq-zwv-041818>

Where To Buy

To find your nearest Qubino dealer visit: <http://qubino.com/where-to-buy/>

1. Introduction

The Flush 2 Relay controls on/off function for two electrical devices (door locks, door openers, fans, etc.) or lights. It measures power consumption of the connected device, and can be paired with a digital temperature sensor (sold separately). It supports push-button/momentary switches and toggle switches (default).

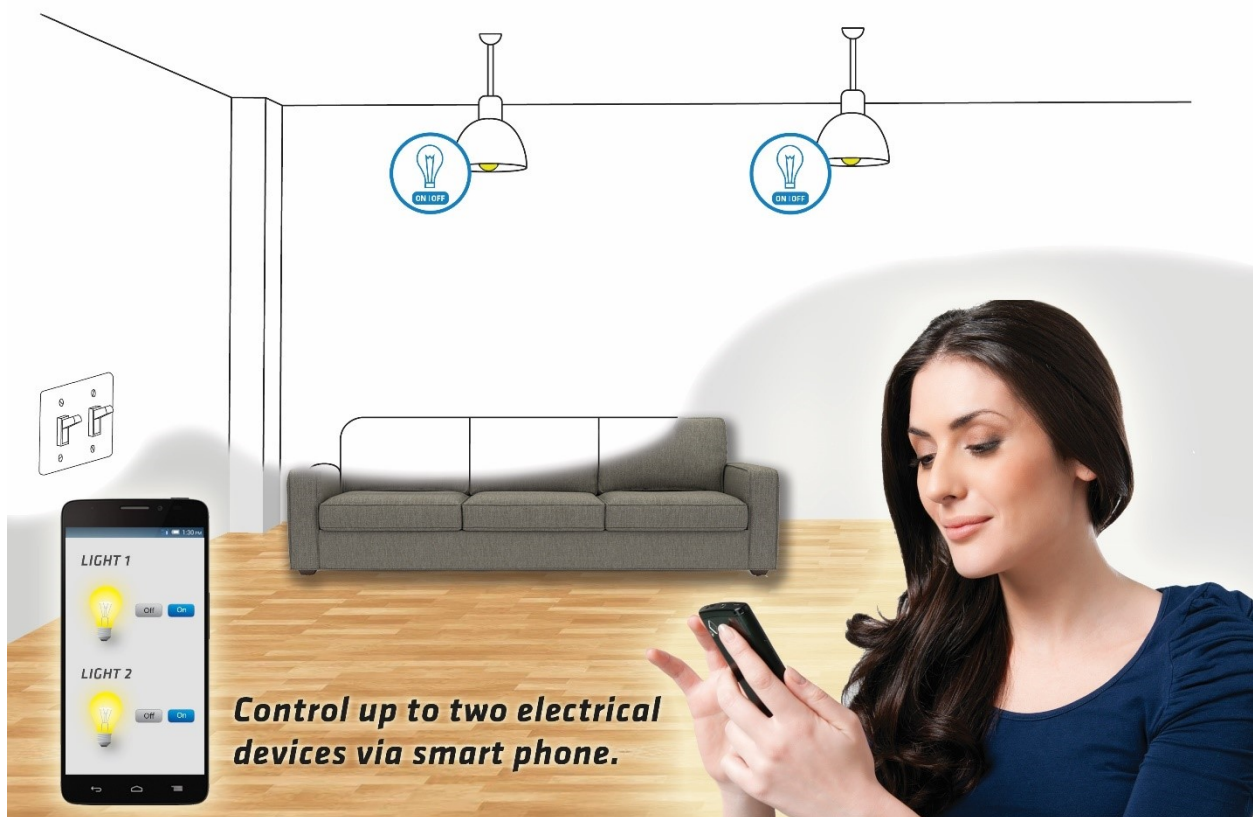

The connection of a digital temperature sensor means you can create complex scenes and control any device relative to a set temperature range. The Qubino Flush 2 Relay also acts as a Z-Wave repeater to improve the range and stability of the Z-Wave network.

Flush 2 Relay supported functions:

Turn ON/OFF Device 1	Turn ON/OFF Device 2	Turn ON/OFF Both devices together	W Measurement Device 1	W Measurement Device 2	W Measurement Both devices together	kWh Measurement Device 1	kWh Measurement Device 2
✓	✓	✓	✓	✓	✓	✓	✓







kWh Measurement Both devices together	Automatically turn ON/OFF Device 1	Automatically turn ON/OFF Device 2	Automatically turn ON/OFF Both devices together	Temperature Sensor	Associations	Z-Wave Repeater	Auto-inclusion
✓	✓	✓	✓	✓	✓	✓	✓

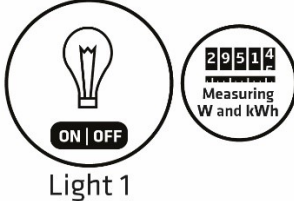
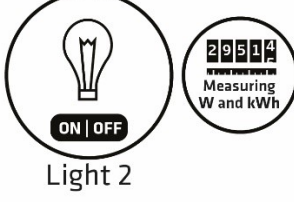
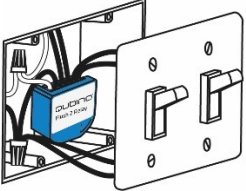

2. Use Cases

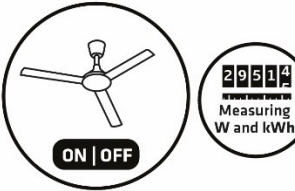
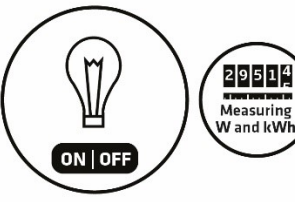
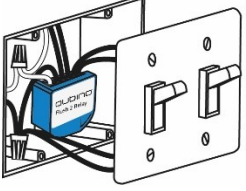
The Flush 2 Relay can be used in many different scenes, which can help make your life more comfortable. We have prepared a few of them for you—so you can get an idea for your next smart home project. Of course, there are countless of other options for how to use Qubino Flush 2 Relay to remotely control devices via your smartphone.

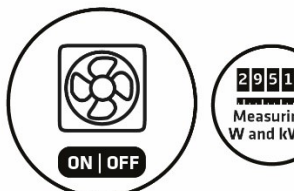
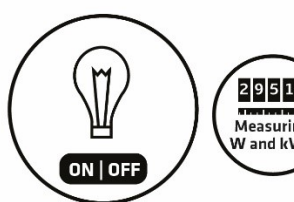
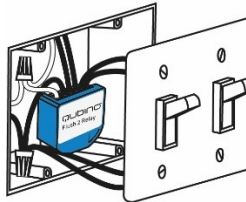
2.1. Installation examples where Flush 2 Relay is installed behind a wall switch

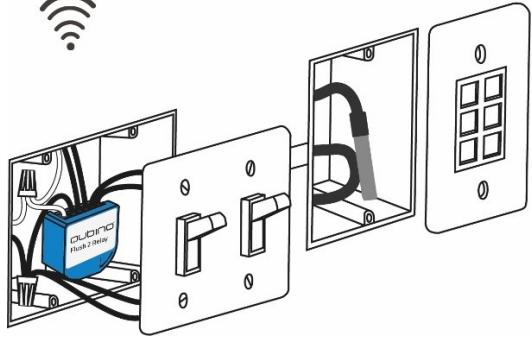
<ul style="list-style-type: none">Remotely control two lights    	<ul style="list-style-type: none">Remotely control ceiling fan and light    
<ul style="list-style-type: none">Remotely control wall-mounted fan and light    	<ul style="list-style-type: none">Remotely measure room temperature (*The temperature sensor is sold separately - for more info, please see Qubino catalogue. Product ordering code (model number): ZMNHEA1)   

2.2. Installation examples where Flush 2 Relay is installed in electrical box

- Remotely control two irrigation sprinkle valves - 24 VDC, option 1

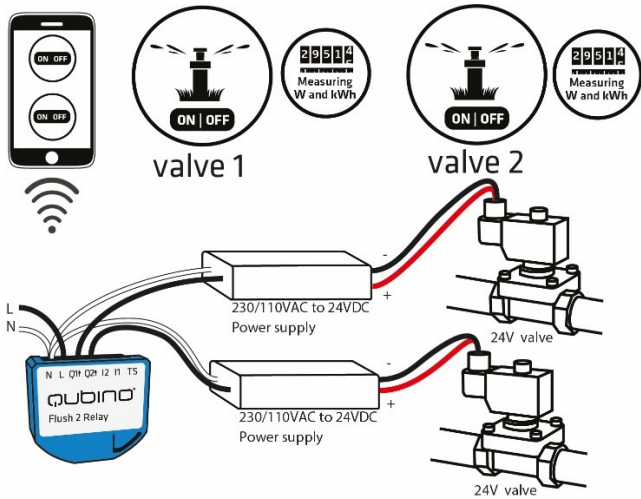

- Remotely control two irrigation sprinkle valves - 24 VDC, option 2

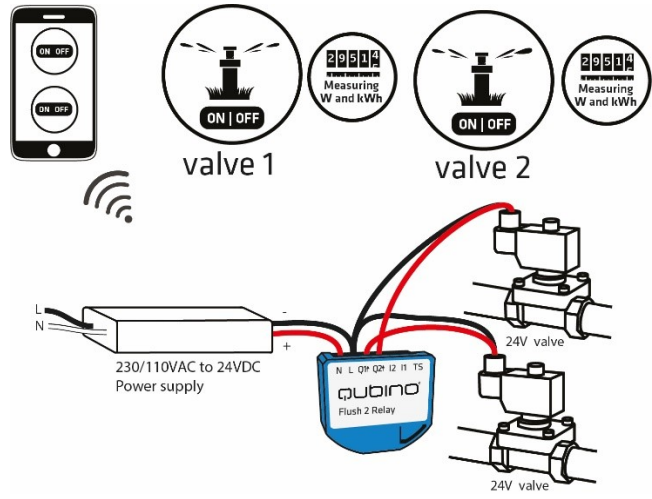

2.3. Additional features of Flush 2 Relay which can make your life easier

- **Do you worry that your irrigation system can expose your garden to flooding?**
- Sometimes your Z-Wave gateway (hub) can stop working while you're away from home (no internet connection, power outage, etc). If you have an irrigation scene scheduled, your gateway (hub) might not send an OFF command to your irrigation system, leaving your garden flooded and water bill more expensive than you'd like. The Flush 2 Relay offers the option to set the timing for irrigation for a specific amount of time internally; it then automatically stops watering, completely independent of your gateway's (hub's) commands.

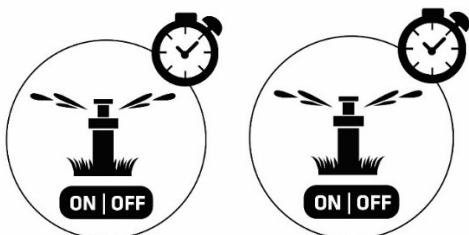

For the 24VDC use case, please check the chapter above.

- **Do you often forget to turn off devices when you leave your home, like lights in the basement or attic?**
- The Flush 2 Relay can automatically turn devices/lights on or off after a set period of time (when you're away from home). For example, the lights will automatically turn off if it's been on for 8 hours, let's say. This function is independent of other scenes and gateway (hub) commands.

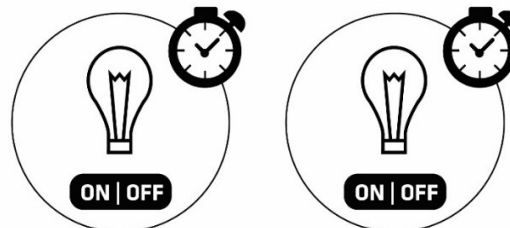

- Do you know how much energy you consume?
- The Flush 2 Relay monitors and reports energy consumption of connected devices in real time to your smart home app (your gateway (hub) needs to support this feature). Know how much power your light or other connected devices is using.

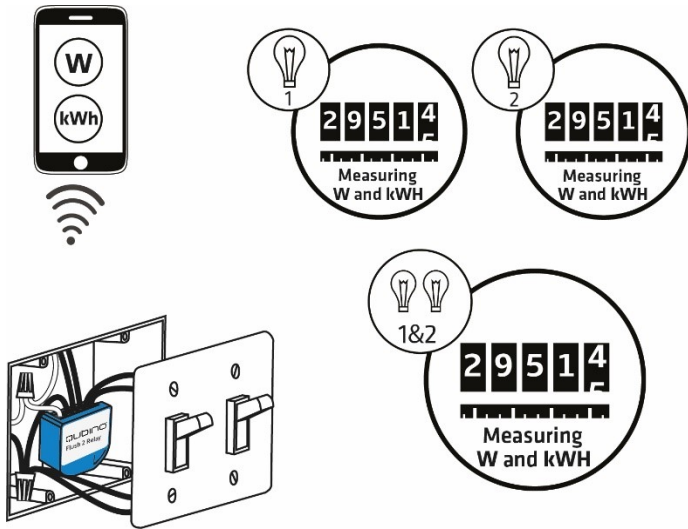

- Want to control other devices in your Z-Wave network with the Flush 2 Relay?
- Connect the Flush 2 Relay with other devices in your network to remotely and automatically trigger another Z-Wave device. And have other Z-Wave devices trigger your Qubino Flush 2 Relay.

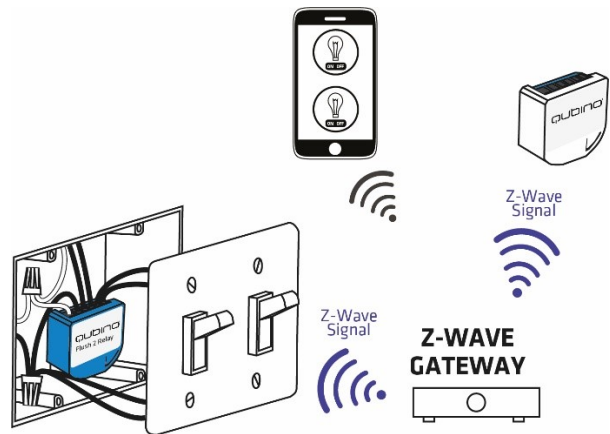

3. Qubino Flush 2 Relay Advantages and Highlights

3.1. Advantages

- The Qubino Flush 2 Relay allows the **easiest and quickest installation possible**. Because of its small size, it fits smoothly in even the smallest, most shallow and-most crowded flush mounting boxes, which are stuffed with lots of electrical cables and where **every millimetre counts**. All this is possible because the Qubino Flush 2 Relay is **the smallest Z-Wave switch in the world**.

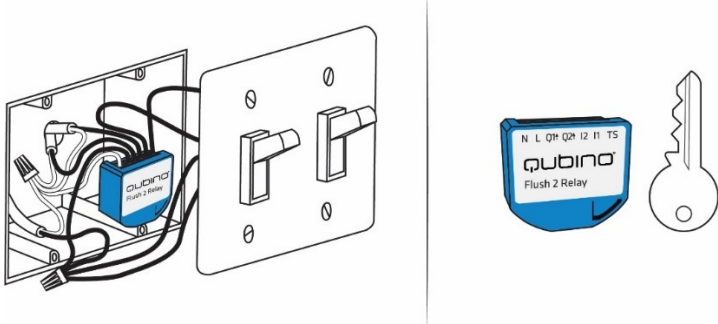

- The Qubino Flush 2 Relay has the **option to connect a temperature sensor***, through which users can monitor the ambient air or water temperature. It’s the only Z-Wave switch in the world which offers this option. With a connected sensor, the user can monitor accurate measurements of the room temperature, pool water temperature, etc., and remotely change conditions as desired. Qubino relay, along with the temperature sensor, is connected directly to the power supply. Install it and forget it – no need to worry about dying batteries, like with battery-powered sensors.

*The temperature sensor is sold separately - for more info, please see Qubino catalogue. Product ordering code (model number): ZMNHEA1



ⓘ Please do not put the temperature sensor directly into the water! The temperature sensor is designed to measure the water temperature by being mounted to the water pipe.

- Qubino guarantees **100% device quality**. Such high quality can be delivered because every Qubino goes through rigorous quality control standards throughout the production process. Every device has a unique serial number and a part number, which are assigned to the device only after it goes through a strict testing procedure.



- By scanning the QR code on the back of your Qubino device, the serial and part numbers will be automatically copied on your mobile phone; they also provide **direct access to Qubino's technical support team**. The serial and part numbers of your device are given automatically every time you open an inquiry with our support team: this instantly shares the relevant device information we need to provide the best technical support possible. For details, please see the Device Information and Support chapter.



- The Qubino Flush 2 Relay is **engineered and manufactured in the EU** and contains only the highest quality components.



- The Qubino Flush 2 Relay is certified by an independent European Institute and has CE, FCC, LVD and EMC certificates to ensure the highest safety standards.

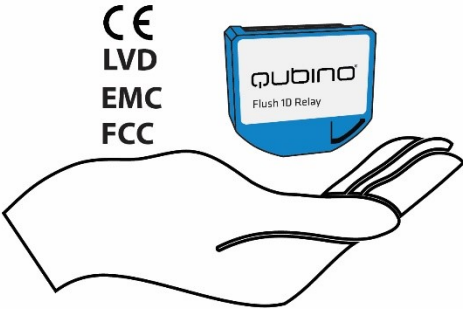

3.2. Highlights







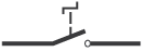

- Remote (via smartphone or PC) and local on/off control of bulbs and other electrical devices
- Works with push-button (momentary switch) and toggle switch
- Capable of measuring the power consumption of the connected device in real time via smartphone, which allows you to save on electricity bills*
- Features one of the easiest and quickest installations of devices of this kind; fits in even the smallest flush mounting boxes
- Saves and restores the last status after a power failure-
- Supports auto-inclusion mode for quick set up
- Can automatically turn devices on and off after a set period of time (helpful when you're away from home, for example) *
- Supports additional parameters for expert users, which allows advanced configuration*
- Acts as a signal repeater which improves the range and stability of your Z-Wave network
- Can be used to remotely control and trigger other devices in your Z-Wave network

*Your gateway (hub) needs to support advanced configuration and parameter input if you wish to use this feature

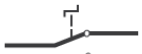
4. Package Contents

- Flush 2 Relay Device
- Installation Manual

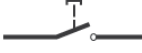
5. Technical Terms for Switches

Symbol	Switch example images	Definition	EU	USA	Qubino	Other names
		Single pole, single throw (SPST) - One switch controlling one light / circuit of lights	One-way switch	Two-way switch (regular switch)	Toggle switch	Switch; Bi-stable switch
		Single pole, double throw (SPDT) - Two switches controlling the same light / circuit of lights	Two-way switch	Three-way switch	Two-way switch	
		Used when you have three or more switches controlling the same light	Intermediate switch	Four-way switch	Intermediate switch	Crossover switch; Cross connection
		After being released, it goes back to its original state	Momentary switch		Momentary switch	Monostable switch; Push button

Qubino devices are installed into flush mounting boxes behind the switches. You can see some examples below:

For more information on how to install your device, please refer to the Installation chapter.

EU example:

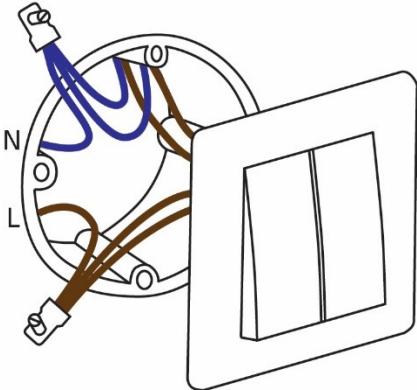

USA example:

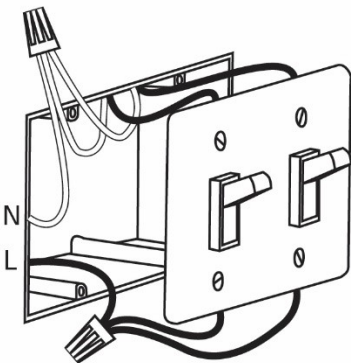

ITA/Brasil example:

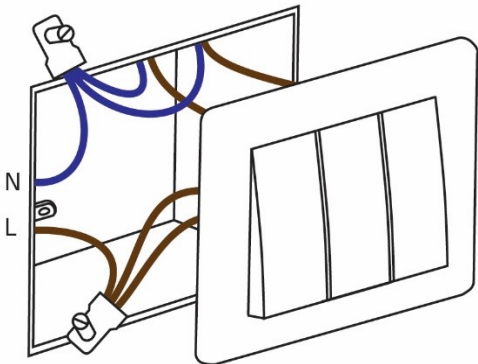

6. Compatibility with Z-Wave Gateways (hubs)

Please check compatibility with your Z-Wave gateway (hub) before you purchase this device. If you don't see your gateway (hub) in the table below, please contact us at: <http://qubino.com/support/#email>.

i Please note that the gateway (hub) compatibility was updated on 14.3.2018 and it may not include the latest testing data.

Flush 2 Relay	Q1+Q2	Q1	Q2	W	W (Q1)	W (Q2)	kWh	kWh (Q1)	kWh (Q2)	Temp	Comments
Domoticz V3.5877	✓	✓	✓	✓	T	T	T	T	T	✓	
Fibaro HC Lite v 4.130	✓	✓	✓	O	O	O	O	O	O	✓	Set Multichannel association in group 1 for root device.
Vera Edge v 1.7.2406	✓	O	O	✓	T	T	T	T	T	✓	
Zipabox1.1.38	✓	✓	✓	✓	T	T	T	T	T	✓	
Z-Wave Me	✓	✓	✓	✓	T	T	T	T	T	✓	
Homeseer 3.0.0.368	X	✓	✓	✓	✓	✓	X	T	T	✓	
Open Z-Wave	✓	✓	✓	✓	T	T	T	T	T	✓	
Piper	✓	X	X	X	T	T	T	T	T	X	
SmartThings 3rd party	O	✓	O	✓	T	T	T	T	T	✓	Q2 control needs additional handler installed.
NETIChome	✓	✓	✓	✓	T	T	T	T	T	✓	
Homey	T	T	T	T	T	T	T	T	T	T	
Eedomus	✓	✓	✓	✓	T	T	T	T	T	✓	
Jeedom	✓	✓	✓	O	T	T	T	T	T	✓	Activate the pooling (configuration: Values and refresh)
Zipatile	✓	✓	✓	✓	T	T	T	T	T		
Devol	X	✓	✓	X	X	X	T	T	T	X	
Verbund	T	T	T	T	T	T	T	T	T	T	
Indigo 7	X	✓	✓	X	✓	✓	T	T	T	✓	
ImperiHome	✓	✓	✓	✓	✓	✓	T	T	T	✓	
OpenHab	✓	✓	✓	✓	✓	✓	T	T	T	X	

Symbol	Explanation
✓	Works fully
×	Not working
O	See comment
T	Testing in progress

7. Installation

Before installing the device, please read the following carefully and follow the instructions exactly:

ⓘ Danger of electrocution!

Installation of this device requires a great degree of skill and may be performed only by a licensed and qualified electrician. Please keep in mind that even when the device is turned off, voltage may still be present in the device's terminals.

ⓘ Note!

Do not connect the device to loads exceeding the recommended values. Connect the device exactly as shown in the provided diagrams. Improper wiring may be dangerous and result in equipment damage.

Electrical installation must be protected by directly associated overcurrent protection fuse (F1) 10A, gG or Time lag T, rated breaking capacity 1500A (ESKA 522.727) and (F2) 4A, gG or Time lag T, rated breaking capacity 1500A (ESKA 522.723) must be used according to wiring diagram to achieve appropriate overload protection of the device. The fuse must be installed in fuse holder type: Adele contact 503Si/1 DS according to the standard IEC60669-2-1.

7.1. Installing the device behind a light switch

The installation process, tested and approved by professional electricians, consists of the following simple steps:

Step 1 – Turn OFF the fuse:

- To prevent electrical shock and/or equipment damage, disconnect electrical power at the main fuse or circuit breaker before installation and maintenance.
- Be aware that even if the circuit breaker is off, some voltage may remain in the wires — before proceeding with the installation, be sure no voltage is present in the wiring.
- Take extra precautions to avoid accidentally turning the device on during installation.

STEP 1

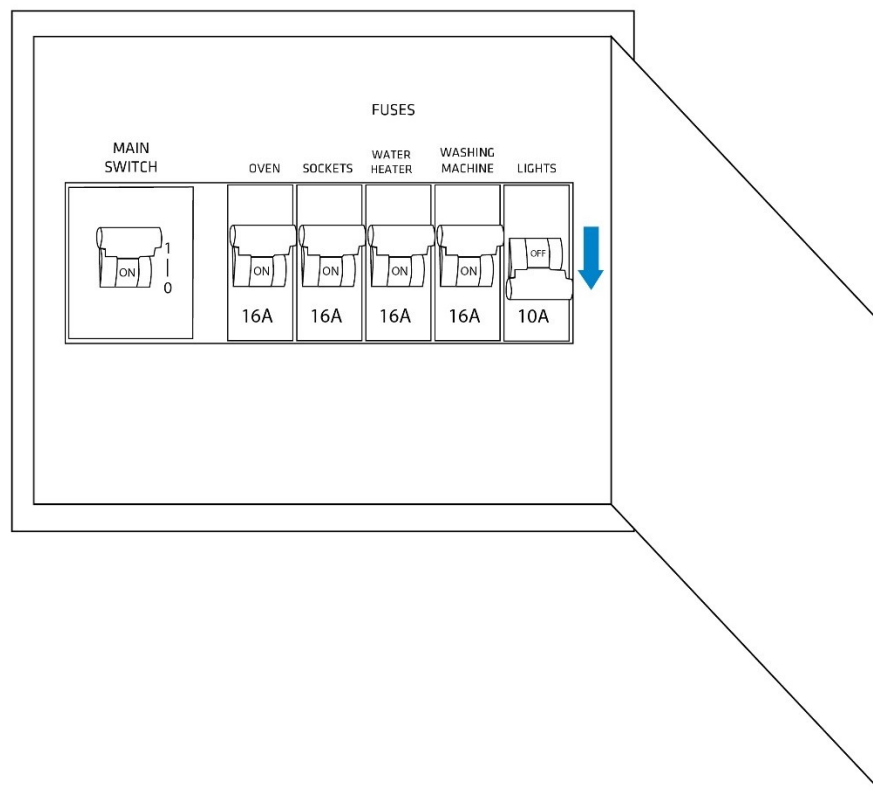

Step 2 – Installing the device:

- Connect the device exactly according to the diagrams shown below

STEP 2

Before Qubino installation:

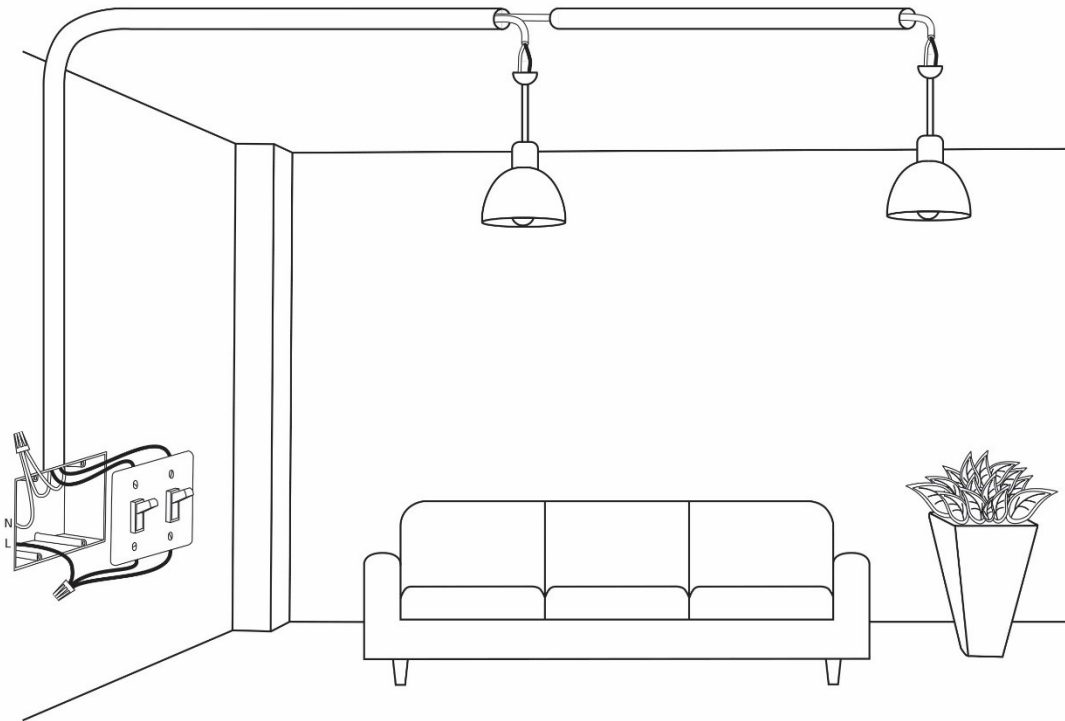

EU example:

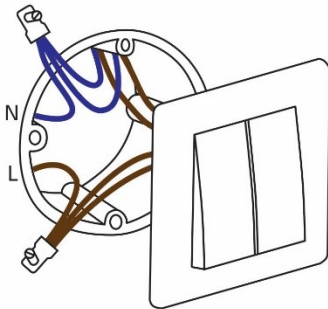

USA example:

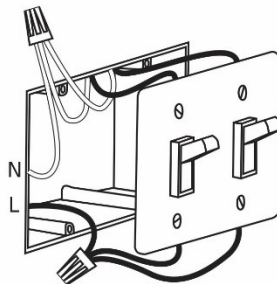

ITA/Brasil example:

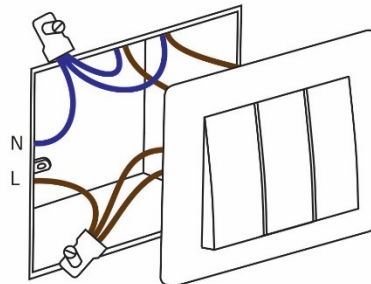

Installation and wire connections are the same in USA, EU and ITA/Brasil.

After Qubino installation:

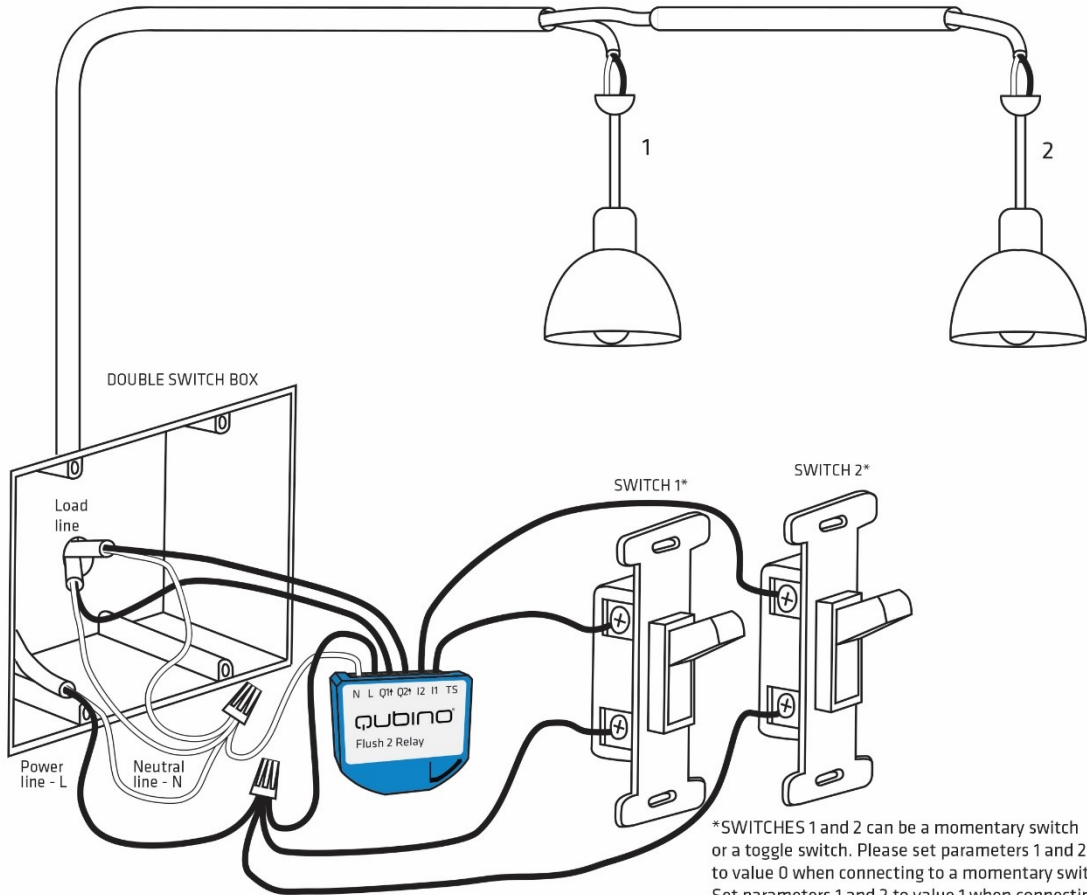

*SWITCHES 1 and 2 can be a momentary switch or a toggle switch. Please set parameters 1 and 2 to value 0 when connecting to a momentary switch. Set parameters 1 and 2 to value 1 when connecting to an on/off toggle switch (default setting). Please see the Configuration Parameters chapter for more information about advanced parameter settings

Installation in the switch box:

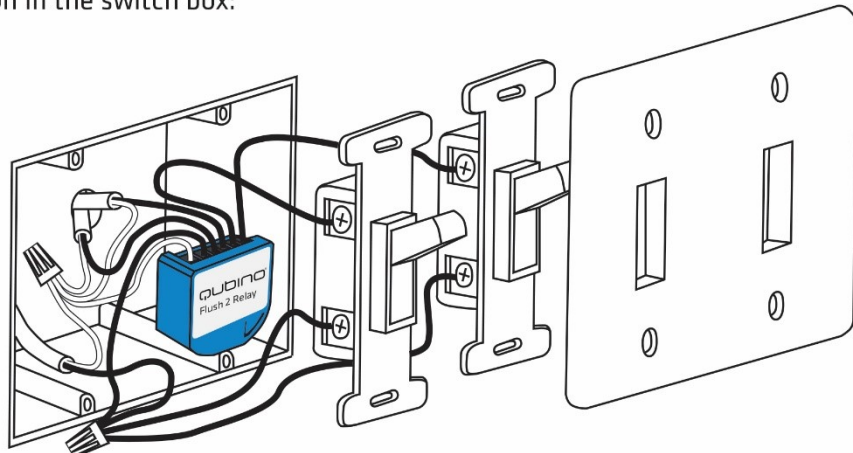

*This diagram is for single pole installation only. Refer to appropriate diagram for 3-way installation.

3-WAY INSTALLATION WITH 2 SWITCHES CONTROLLING THE SAME LIGHT:

Before Qubino installation:

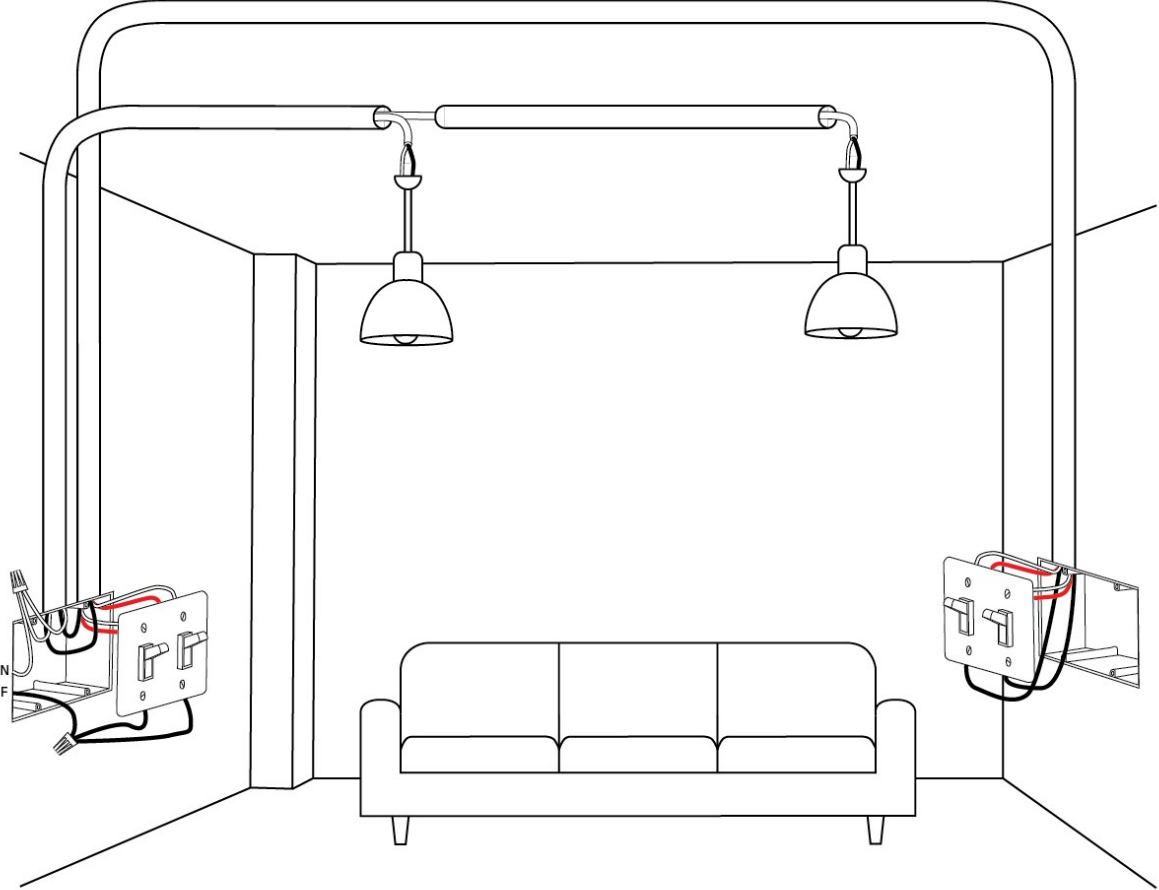

After Qubino installation:

(when power line and load line are in the same switch box)

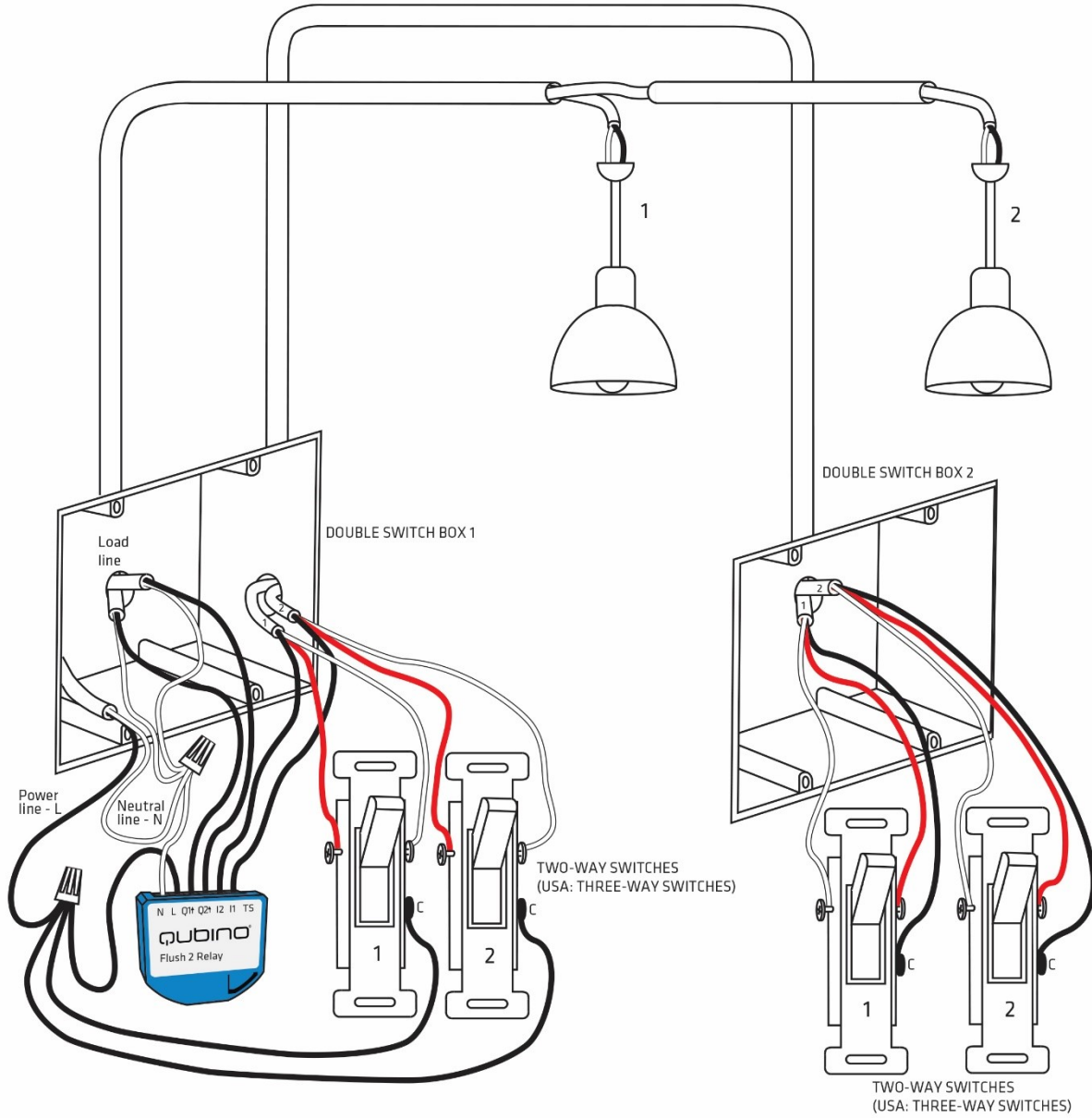

After Qubino installation:

(when power line and load line are in different switch boxes)

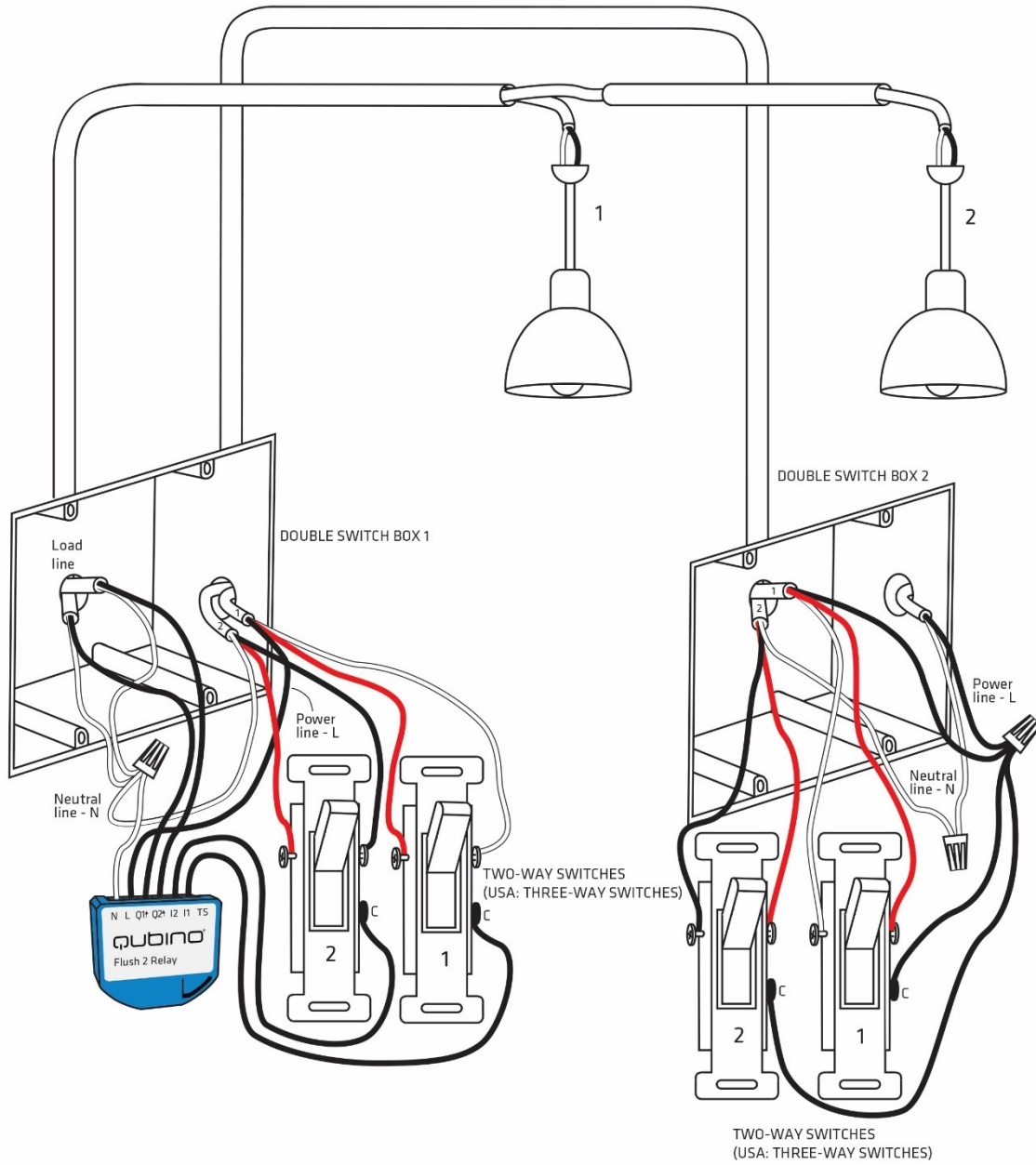

Before Qubino installation:

(Where there is no neutral line (N) in switch box)

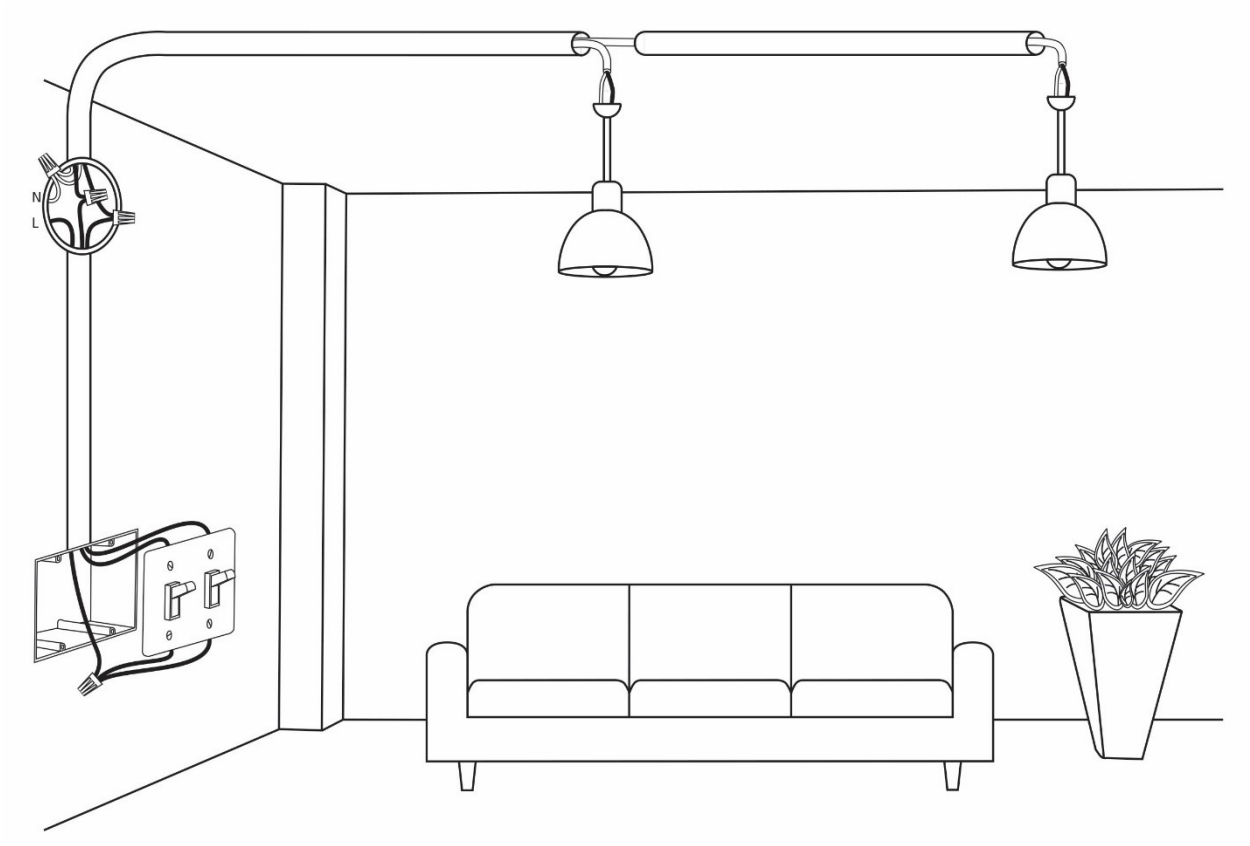

After Qubino installation:

(Where there is no neutral line (N) in switch box)

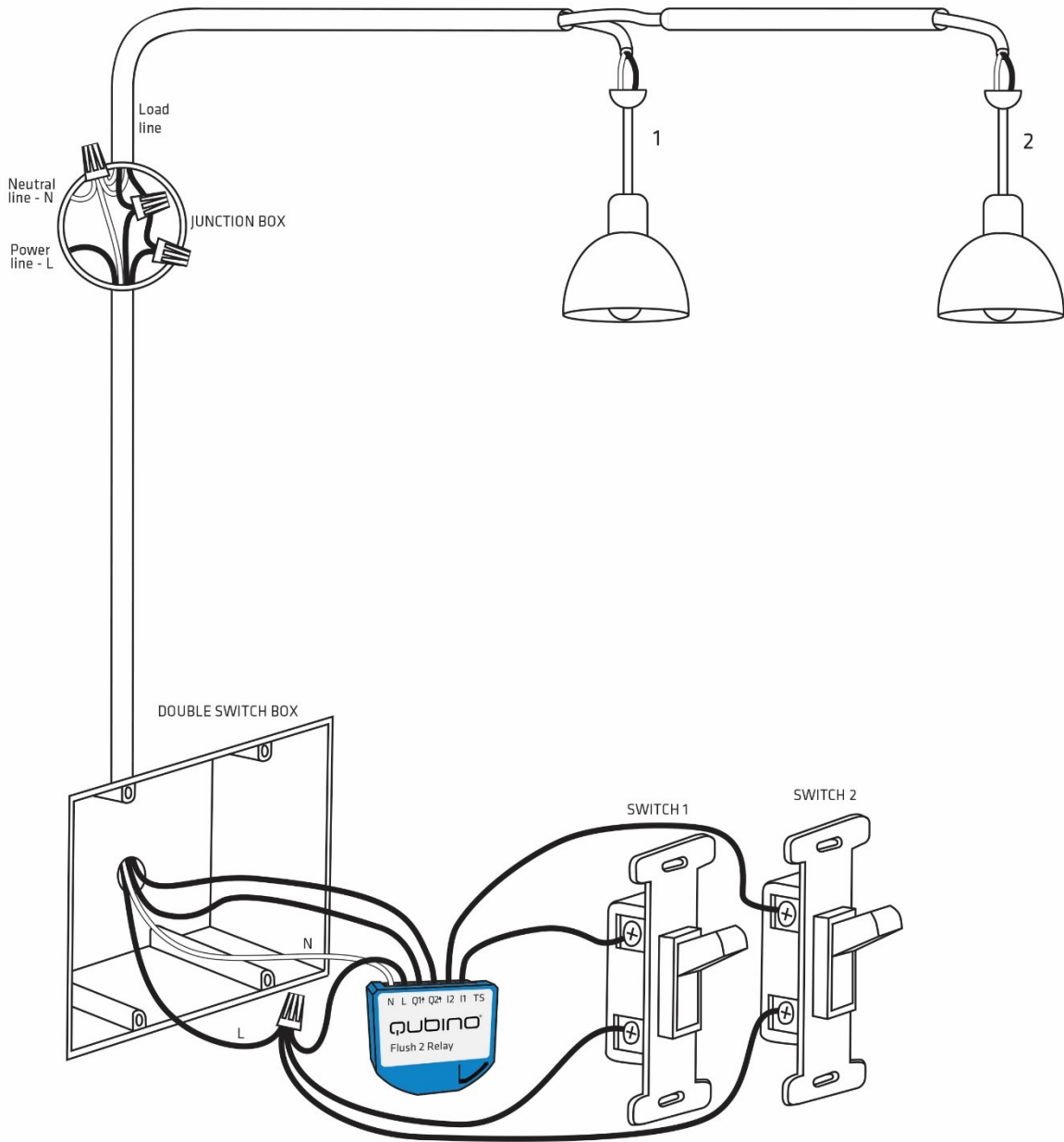

i Note!

- Place the antenna as far as possible from metal elements as they may cause signal interference.
- Do not shorten the antenna.

The device's antenna should be as upright as possible. This ensures the device's operational range is maximized (up to 98 feet (30 m) line of sight).

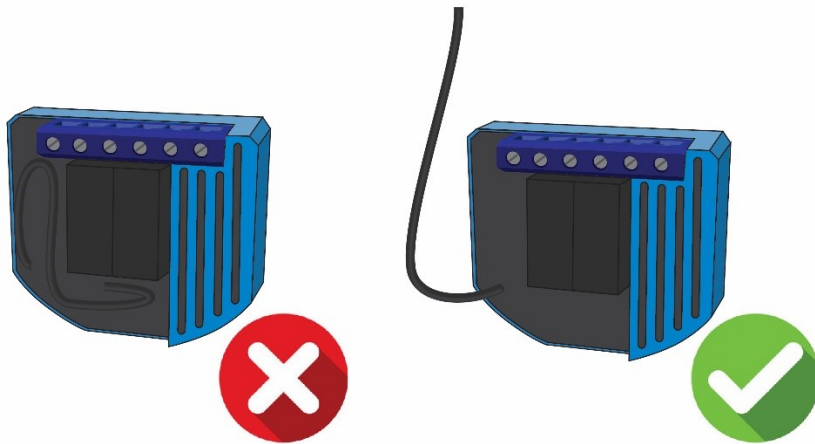

Step 3 – Turn ON the fuse:

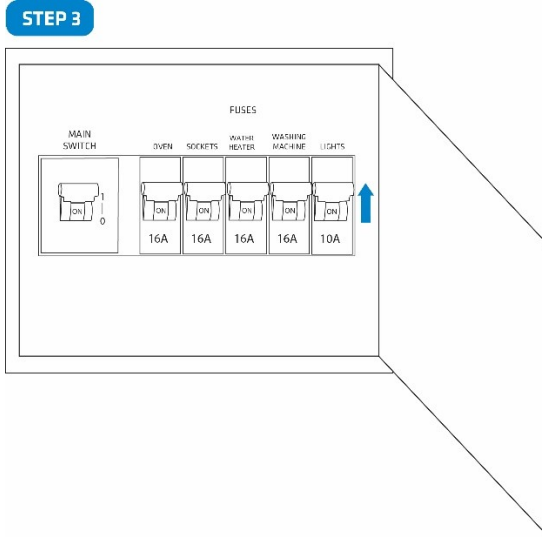

Step 4 – Add the device to your Z-Wave network:

- For more details on how to include the device, please refer to the Z-Wave Inclusion chapter.



Step 5 – The Installation is now complete. It’s time to make your life more comfortable with the help of the Qubino Flush 2 Relay

STEP 5

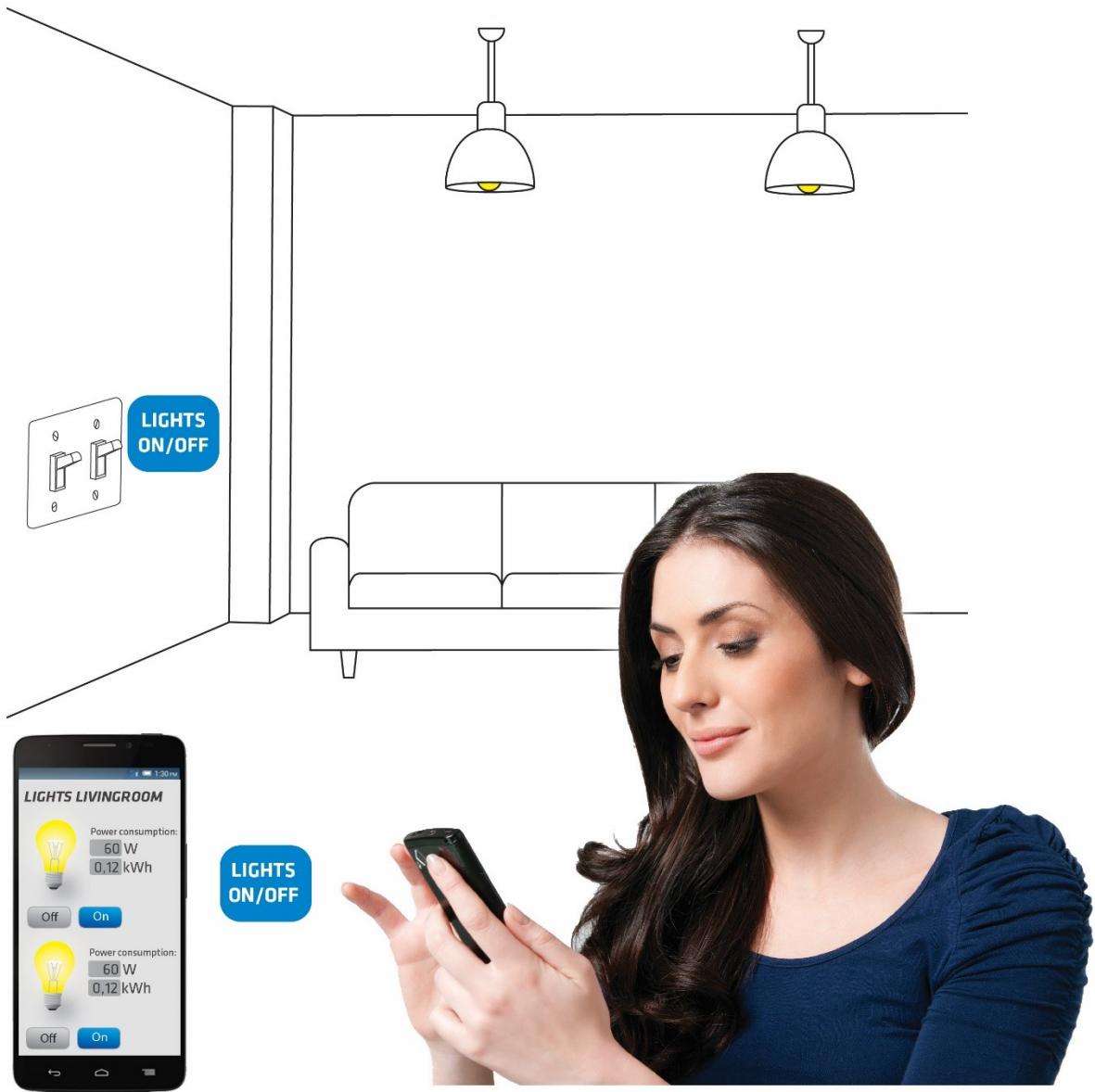

7.2. Installing the Qubino Temperature Sensor

The temperature sensor is a Qubino accessory and is sold separately - for more info, please see the Qubino product catalogue or website: <http://qubino.com/products/accessories/>

Product ordering code: ZMNHEA1

Qubino Z-Wave devices have the option to connect a temperature sensor (sold separately), which allows you to **remotely monitor ambient or water temperature**. Qubino devices are the only Z-Wave devices of its kind to offer this unique capability. With the sensor connected to the device, you can carry out accurate measurements of room temperature, pool water temperature, etc. and build automation rules around them. Qubino device with a temperature sensor is connected directly to power supply. Install it and forget it, there is no need to worry about changing the batteries like with most other Z-Wave temperature sensors which run on batteries. The temperature sensor's range is between -50° and 125°C (-58° and 257° F).

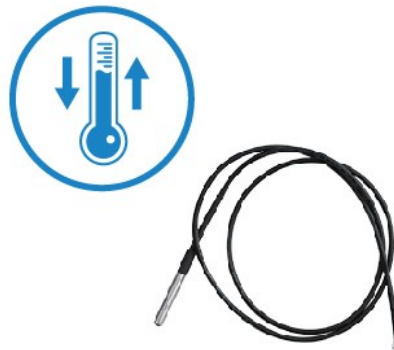

The digital Temperature sensor comes with a 1 m (3.3 ft) cord and a connector to attach it directly to a Qubino device.

1. To prevent electrical shock, make sure that no voltage is present on the temperature sensor cable.
2. When connected to Qubino device, the temperature sensor is under high voltage, which is very dangerous.
3. Goap d.o.o. does not take responsibility for any damage or electrical shock due to incorrect sensor assembly.
4. The above instructions and description apply to a temperature sensor compatible with Qubino products only.

NOTE: When Qubino is wired to 110-240VAC (high voltage) the temperature sensor must not be in direct contact with water.

Temperature sensor installation example:

Step 1 – Exclude the device (if it is already connected to your Z-Wave system)



Step 2 – Switch of the power supply

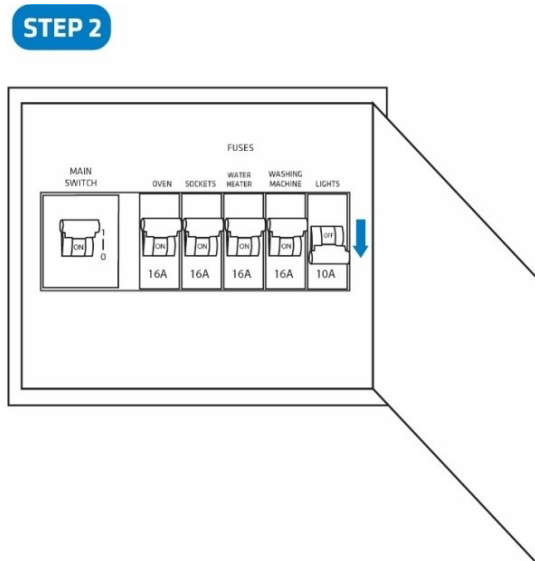

Step 3 – Connect the temperature sensor as shown below

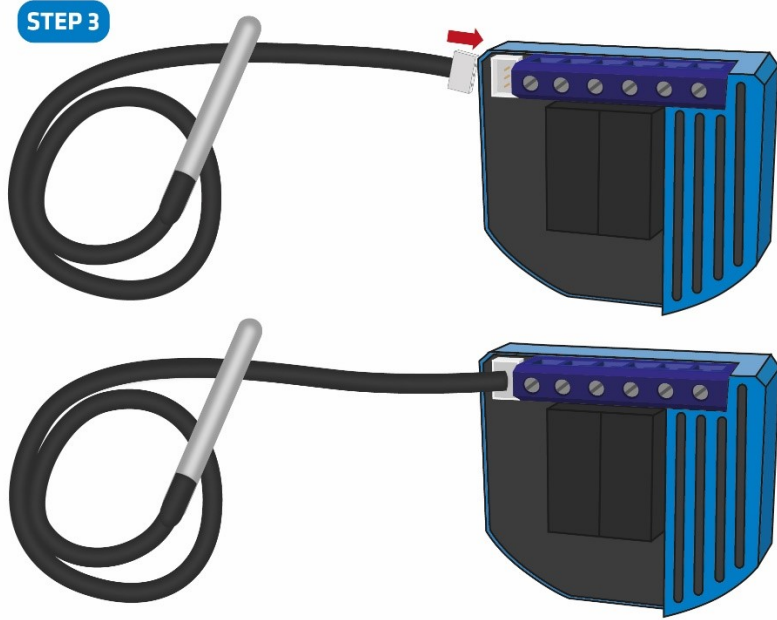

Step 4: Place the temperature sensor in the switch box

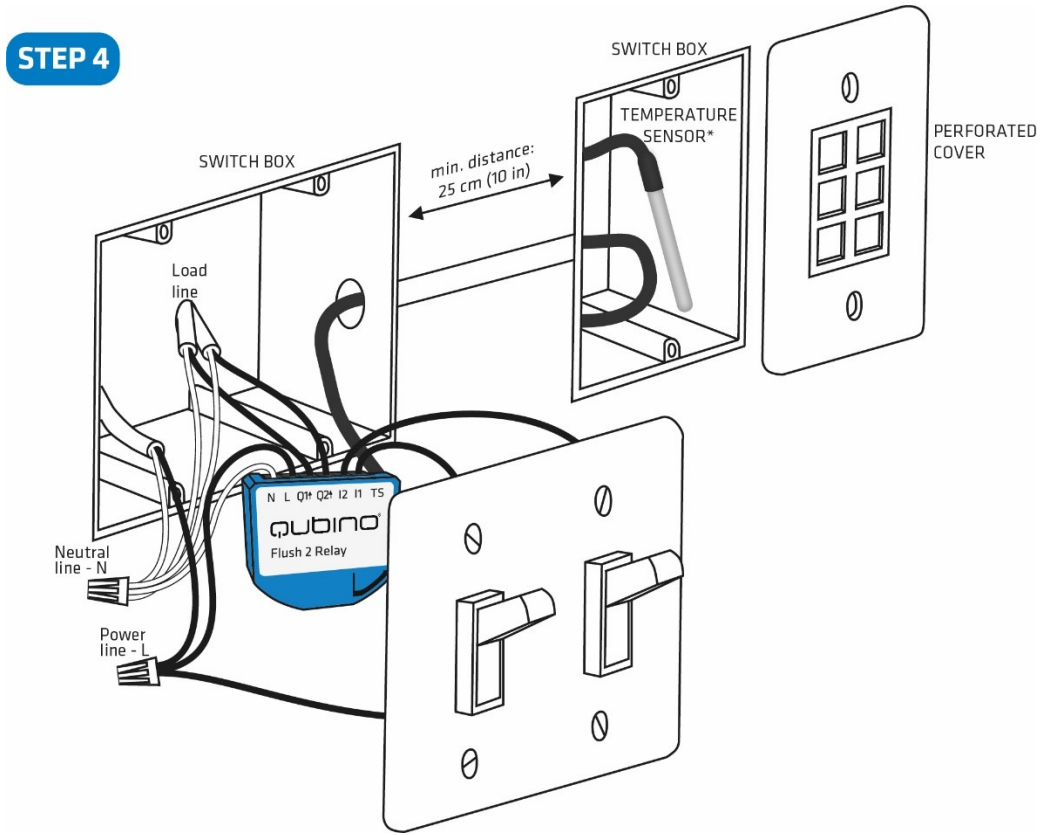

Step 5 – Turn the fuse on

STEP 5

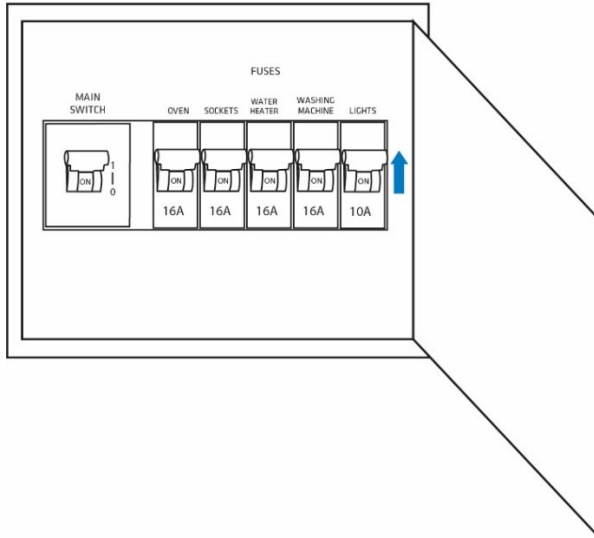

Step 6 – Re-include the device to your network

STEP 6



Step 7 – Start using the temperature sensor in connection with your device

STEP 7

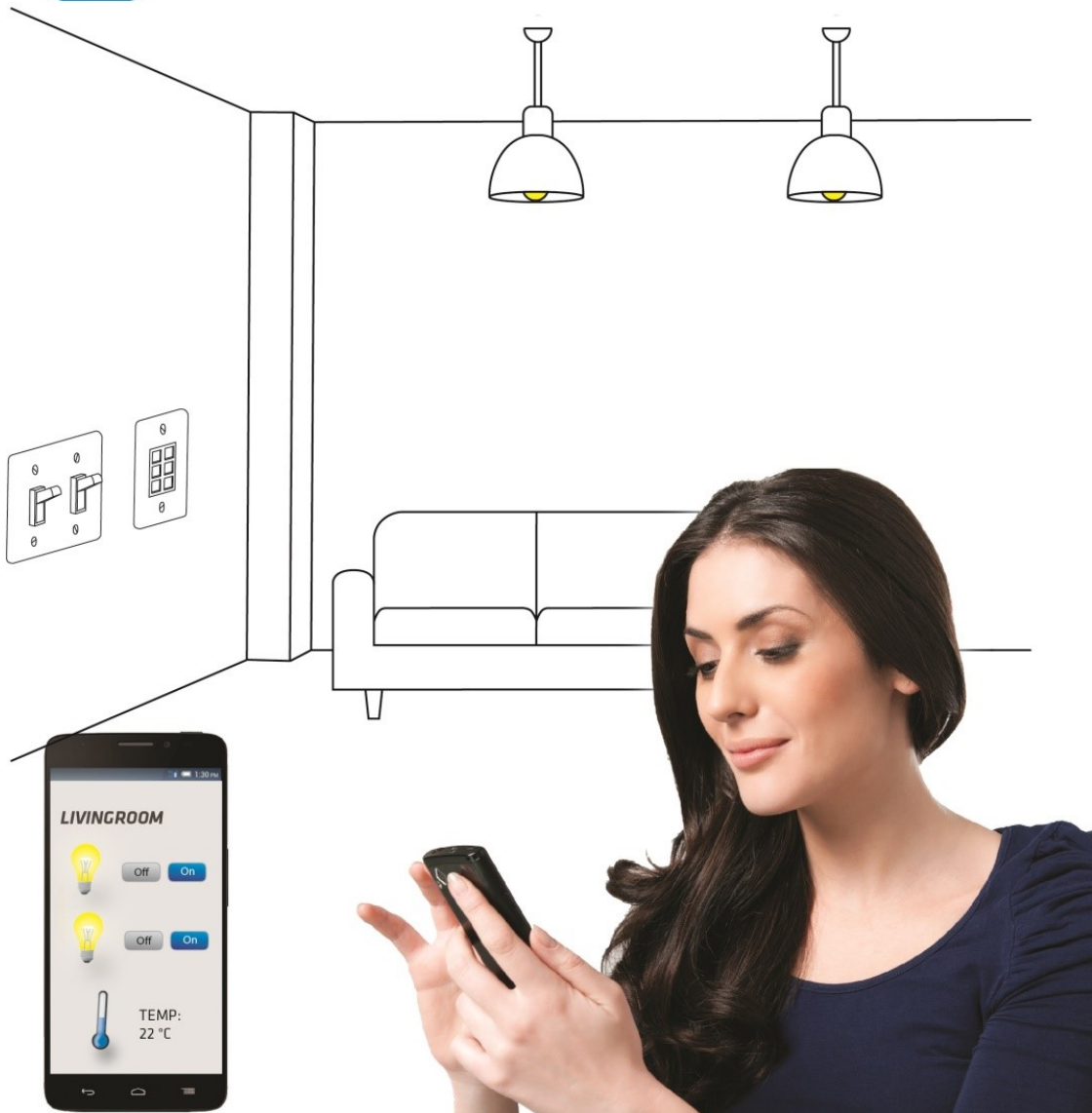

8. Device Information and Support

Did you know that Qubino offers Z-Wave devices with 100% quality control guaranteed throughout the production process? Every single unit is tested and examined before being approved for sale – a truly unique pledge in the industry.

Why is this important?

Every device has a dedicated serial number and part number, which is assigned to the device only after it goes through a strict testing procedure.

By scanning the QR code on the back of your Qubino, its device title, serial number, and part number are automatically copied to your mobile phone. You can also use the code for direct access to the device page for more information. If you still don't find what you're looking for, click on the link to Qubino technical support team. They will be able to automatically read the serial and part number from your device and quickly review the production log file containing the production date as well as any relevant device parameters and information. This process allows our team to immediately identify and address issues, giving you the best support possible.

GET SUPPORT IN 3 SIMPLE STEPS:



Based on customer and business partner feedback, we're proud to boast Qubino's support team as the best and fastest on the market. If you don't find the answers to your questions in this document, please contact our support team by scanning the QR code on your device or through our website: <http://qubino.com/support/#email>. We will try to help you as soon as possible.

9. Electrical Diagram (110 – 240VAC, 24VDC)

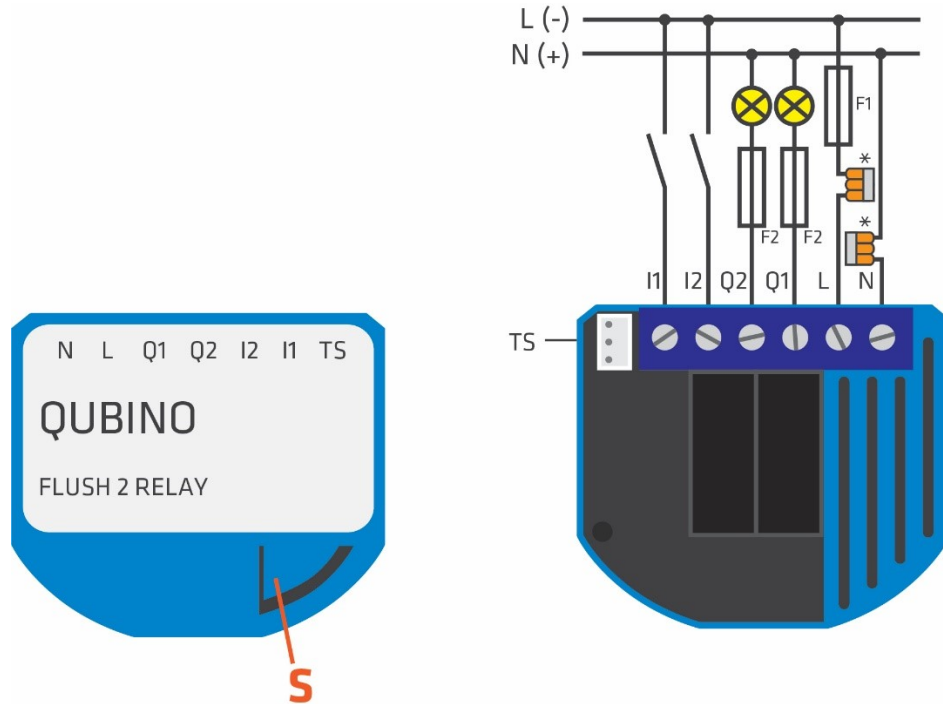

Notes for diagram:

N	Neutral wire (+VDC)
L	Live (line) wire (-VDC)
Q1†	Output for electrical device (load) no. 1
Q2†	Output for electrical device (load) no. 2
I2	Input to control electrical device (in-wall switch) no.2
I1	Input to control electrical device (in-wall switch) no.1
TS	Temperature sensor terminal
*	Wago 221-413 splicing connectors for L and N connection must be used only when connected to 240 VAC.
S	Service button

WARNING:

The service (S) button **must NOT be used** when the device is connected to a 110-240V power supply.

The durability of the device depends on the applied load. For resistive loads (light bulbs, etc.) and 4A current consumption of each individual electrical device, the product's lifespan exceeds 70,000 toggles for each individual load.

10. Adding the device to a Z-Wave network (Inclusion)

AUTOMATICALLY ADDING THE DEVICE TO A Z-WAVE NETWORK (AUTO INCLUSION)

1. Enable add/remove mode on your Z-Wave gateway (hub)
2. Connect the device to the power supply (with the temperature sensor already connected – sold separately*).
3. Auto-inclusion will be initiated within 5 seconds of connection to the power supply and the device will automatically enrol in your network

MANUALLY ADDING THE DEVICE TO A Z-WAVE NETWORK (MANUAL INCLUSION)

1. Enable add/remove mode on your Z-Wave gateway (hub)
2. Connect the device to the power supply (with the temperature sensor already connected*)
3. Toggle the switch connected to the I1 terminal 3 times within 3 seconds. The device has to get On/Off signal 3 times, meaning 3 times push on the push button or 6 times press of the switch.

OR

If the device is powered by 24 V SELV supply, press and hold the S (Service) button between 2 and 6 seconds

4. A new multi-channel device will appear on your dashboard

*If connecting the temperature sensor, switch off the power supply and make sure the device is excluded from your network **BEFORE** connecting the sensor.

 Make sure the device is excluded from your network before connecting the temperature sensor. Switch off the power supply, connect the temperature sensor, and re-include the device to your network.

11. Removing the device from a Z-Wave network (Exclusion)

REMOVAL FROM A ZWAVE NETWORK (Z-WAVE EXCLUSION)

1. Connect the device to the power supply
2. Make sure the device is within direct range of your Z-Wave gateway (hub) or use a hand-held Z-Wave remote to perform exclusion
3. Enable add/remove mode on your Z-Wave gateway (hub)
4. Toggle the switch connected to the I1 terminal 3 times within 3 seconds

OR

If the device is powered by 24 V SELV supply, press and hold the S (Service) button between 2 and 6 seconds

5. The device will be excluded from your network but any custom configuration parameters will not be erased

FACTORY RESET

1. Connect the device to the power supply
2. Within the first minute (60 seconds) the device is connected to the power supply, toggle the switch connected to the I1 terminal 5 times within 3 seconds (5 times change switch state).

OR

If the device is powered by 24 V SELV supply, press and hold the S (Service) button for more than 6 seconds

 By resetting the device, all custom parameters previously set on the device will return to their default values, and the owner ID will be deleted. Use this reset procedure only when the main gateway (hub) is missing or otherwise inoperable.

12. Associations

Use associations for direct communication between the Flush 2 Relay and other devices within your Z-Wave network without the need of your primary gateway (hub).

Association Groups:

Root device:

- Group 1: Lifeline group (reserved for communication with the primary gateway (hub)), 1 node allowed.
- Group 2: Basic on/off (status change report for Q1 load), up to 16 nodes.
- Group 3: Switch binary report (status change report for Q1 load), up to 16 nodes.
- Group 4: Power meter report (power consumption report of Q1 load at status change), up to 16 nodes.
- Group 5: Basic on/off (status change report for Q2 load), up to 16 nodes.
- Group 6: Switch binary report (status change report for Q2 load), up to 16 nodes.
- Group 7: Power meter report (power consumption report of Q2 load at status change), up to 16 nodes.
- Group 8: Multilevel sensor report (external temperature sensor report – sensor sold separately), up to 16 nodes.

End point 1 (Wall Switch I1):

- Group 1: Lifeline group, 0 nodes allowed.
- Group 2: Basic on/off (status change report for Q1 load), up to 16 nodes.
- Group 3: Switch binary report (status change report for Q1 load), up to 16 nodes.
- Group 4: Power meter report (power consumption report of Q1 load at status change), up to 16 nodes.

End point 2 (Wall Switch I2):

- Group 1: Lifeline group, 0 nodes allowed.
- Group 2: Basic on/off (status change report for Q2 load), up to 16 nodes.
- Group 3: Switch binary report (status change report for Q2 load), up to 16 nodes.
- Group 4: Power meter report (power consumption report of Q2 load at status change), up to 16 nodes.

End point 3 (External Temperature Sensor):

- Group 1: Lifeline group, 0 nodes allowed.
- Group 2: Multilevel sensor report (external temperature sensor report – sensor sold separately), up to 16 nodes.

13. Configuration Parameters

Parameter no. 1 – In-wall Switch Type for Load 1 (Q1)

With this parameter, you can select between push-button (momentary) and on/off toggle switch types.

Values (size is 1 byte dec):

- default value 1
- 0 - push-button (momentary)
- 1 - on/off toggle switch

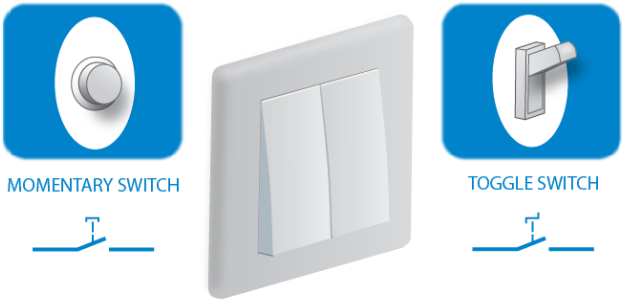

Parameter no. 2 – In-wall Switch Type for Load 2 (Q2)

With this parameter, you can select between push-button (momentary) and on/off toggle switch types.

Values (size is 1 byte dec):

- default value 1
- 0 - push-button (momentary)
- 1 - on/off toggle switch

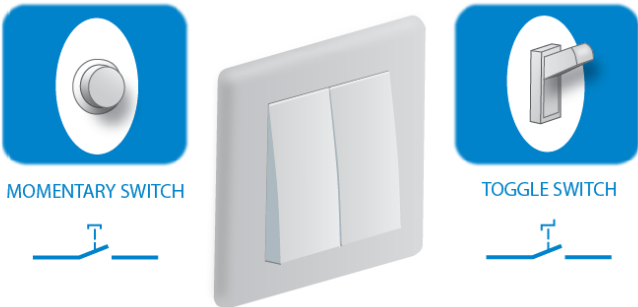

Parameter no. 10 - Activate / deactivate ALL ON/ALL OFF Functionality

Flush 2 Relay device responds to commands ALL ON / ALL OFF that may be sent by the primary or secondary gateway (hub) within the Z-Wave network.

Values (size is 2 byte dec):

- default value 255
- 255 - ALL ON active, ALL OFF active
- 0 - ALL ON not active, ALL OFF not active
- 1 - ALL ON not active, ALL OFF active
- 2 - ALL ON active, ALL OFF not active

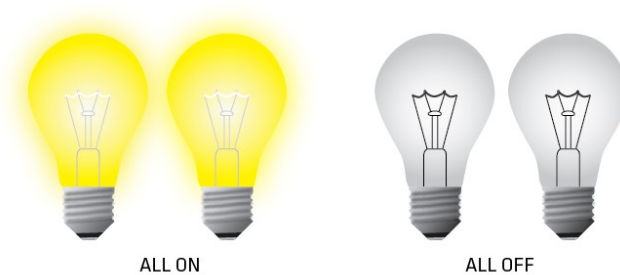
**Parameter no. 11 - Turn Load 1 (Q1) Off Automatically with Timer**

If Load 1 (Q1) is ON, you can schedule it to turn OFF automatically after a period of time defined in this parameter. The timer is reset to zero each time the device receives an ON command, either remotely (from the gateway (hub) or associated device) or locally from the switch.

Values (size is 2 byte dec):

- default value 0
- 0 - Auto OFF Disabled
- 1 - 32535 = 1 - 32535 seconds (or milliseconds – see Parameter no. 15). Auto OFF timer enabled for a given amount of seconds (or milliseconds).

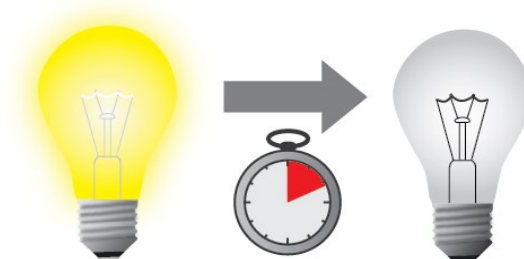

Parameter no. 12 - Turn Load 1 (Q1) On Automatically with Timer

If Load (Q1) is OFF, you can schedule it to turn ON automatically after a period of time defined in this parameter. The timer is reset to zero each time the device receives an OFF command, either remotely (from the gateway (hub) or associated device) or locally from the switch.

Values (size is 2 byte dec):

- default value 0
- 0 - Auto ON Disabled
- 1 - 32535 = 1 - 32536 seconds (or milliseconds – see Parameter no. 15). Auto ON timer enabled for a given amount of seconds (or milliseconds).

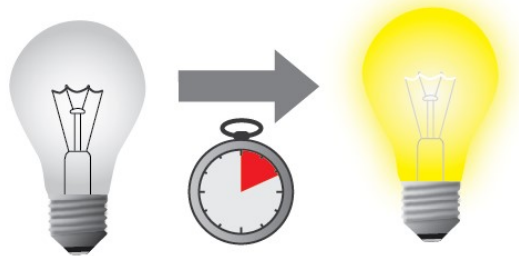
**Parameter no. 13 - Turn Load 2 (Q2) Off Automatically with Timer**

If Load (Q2) is ON, you can schedule it to turn OFF automatically after a period of time defined in this parameter. The timer is reset to zero each time the device receives an ON command, either remotely (from the gateway (hub) or associated device) or locally from the switch.

Values (size is 2 byte dec):

- default value 0
- 0 - Auto OFF Disabled
- 1 - 32535 = 1 - 32535 seconds (or milliseconds – see Parameter no. 15). Auto OFF timer enabled for a given amount of seconds (or milliseconds).

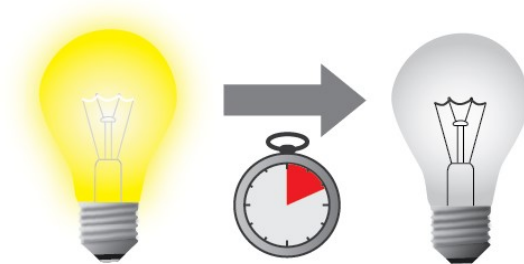

Parameter no. 14 - Turn Load 2 (Q2) On Automatically with Timer

If Load (Q2) is OFF, you can schedule it to turn ON automatically after a period of time defined in this parameter. The timer is reset to zero each time the device receives an OFF command, either remotely (from the gateway (hub) or associated device) or locally from the switch.

Values (size is 2 byte dec):

- default value 0
- 0 - Auto ON disabled
- 1 - 32535 = 1 - 32536 seconds (or milliseconds – see Parameter no. 15). Auto ON timer enabled for a given amount of seconds (or milliseconds).

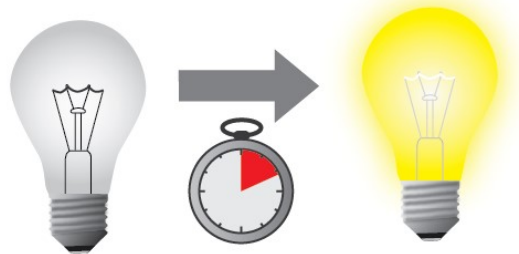

Parameter no. 15 - Set Timer Units to Seconds or Milliseconds

Choose if you want to set the timer in seconds or milliseconds in parameters 11, 12, 13, and 14.

Values (size is 1 byte dec):

- default value 0
- 0 – timer set in seconds
- 1 – timer set in milliseconds

Please note that the value from this parameter applies to settings for Q1 and Q2 loads in all of the above parameters (timer on / timer off).



Parameter no. 30 - Restore on/off status for Q1 and Q2 loads after power failure

This parameter determines if on/off status is saved and restored for both loads after power failure.

Values (size is 1 byte dec):

- default value 0
- 0 - Device saves last on/off status and restores it after a power failure
- 1 - Device does not save on/off status and does not restore it after a power failure, it remains off.

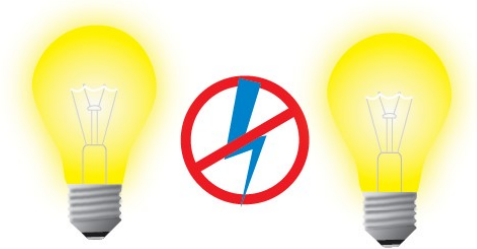
**Parameter no. 40 – Watt Power Consumption Reporting Threshold for Q1 Load**

Choose by how much power consumption needs to increase or decrease to be reported. Values correspond to percentages so if 50 is set (by default), the device will report any power consumption changes of 50% or more compared to the last reading.

Values (size is 1 byte dec):

- default value 50
- 0 - Power consumption reporting disabled
- 1 - 100 = 1% - 100% Power consumption reporting enabled. New value is reported only when Wattage in real time changes by more than the percentage value set in this parameter compared to the previous Wattage reading, starting at 1% (the lowest value possible).

NOTE: Power consumption needs to increase or decrease by at least 1 Watt to be reported, REGARDLESS of percentage set in this parameter.

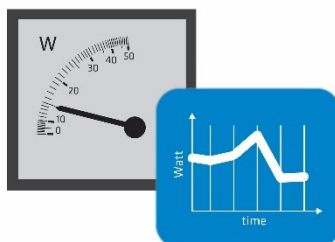

Parameter no. 41 – Watt Power Consumption Reporting Threshold for Q2 Load

Choose by how much power consumption needs to increase or decrease to be reported. Values correspond to percentages so if 50 is set (by default), the device will report any power consumption changes of 50% or more compared to the last reading.

Values (size is 1 byte dec):

- default value 50
- 0 - Power consumption reporting disabled
- 1 - 100 = 1% - 100% Power consumption reporting enabled. New value is reported only when Wattage in real time changes by more than the percentage value set in this parameter compared to the previous Wattage reading, starting at 1% (the lowest value possible).

NOTE: Power consumption needs to increase or decrease by at least 1 Watt to be reported, REGARDLESS of percentage set in this parameter.

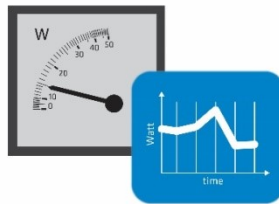
**Parameter no. 42 – Watt Power Consumption Report Time Threshold for Q1 Load**

Set value refers to the time interval with which power consumption in Watts is reported (0 – 32535 seconds). If 300 is entered, energy consumption reports will be sent to the gateway (hub) every 300 seconds (5 minutes).

Values (size is 2 byte dec):

- default value 0
- 0 - Power consumption reporting disabled
- 1 - 32535 = 1 - 32535 seconds. Power consumption reporting enabled. Report is sent according to time interval (value) set here.

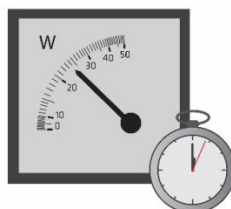

Parameter no. 43 – Watt Power Consumption Reporting Time Threshold for Q2 Load

Set value refers to the time interval with which power consumption in Watts is reported (0 – 32535 seconds). If 300 is entered, energy consumption report will be sent to the gateway (hub) every 300 seconds (5 minutes).

Values (size is 2 byte dec):

- default value 0
- 0 - Power consumption reporting disabled
- 1 - 32535 = 1 - 32535 seconds. Power consumption reporting enabled. Report is sent according to time interval (value) set here.

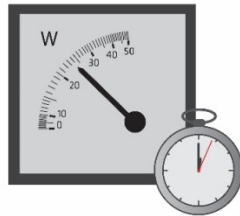
**Parameter no. 63 – Choose Normally Closed or Normally Open as Default for Q1 Load**

Set value determines the type of the device connected to the Q1 output. The device type can be normally open (NO) or normally closed (NC).

Values (size is 1 byte dec):

- default value 0
- 0 - When switch/device is off the output is 0V (NC).
- 1 - When switch/device is off the output is 240V (NO).



Parameter no. 64 – Choose Normally Closed or Normally Open as Default for Q2 Load

Set value determines the type of the device connected to the Q2 output. The device type can be normally open (NO) or normally closed (NC).

Values (size is 1 byte dec):

- default value 0
- 0 - When switch/device is off the output is 0V (NC).
- 1 - When switch/device is off the output is 240V (NO).



Parameter no. 110 – Temperature Sensor Offset Settings

Set value is added to or subtracted from the actually measured value to adjust the temperature report sent by an external sensor (sold separately). This parameter only applies to the Celsius temperature unit (the Fahrenheit unit is currently not supported).

Values (size is 2 byte dec):

- default value 32536
- 32536 - Offset is 0 °C.
- 1 - 100 – Where 1 stands for 0.1°C and 100 stands for 10.0 °C added to the actual measurement.
- 1001 - 1100 – Where 1001 stands for -0.1 °C and 1100 stands for -10.0 °C subtracted from the actual measurement.

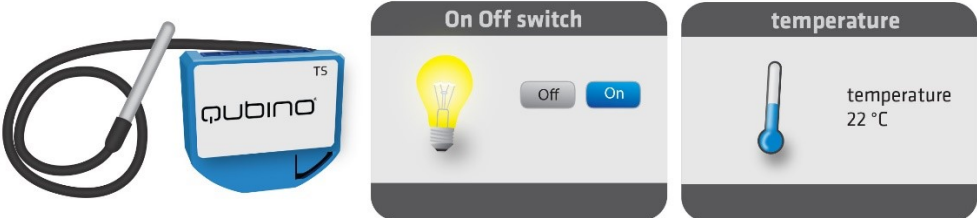

Parameter no. 120 – Temperature Sensor Reporting Threshold

If an external digital temperature sensor (sold separately) is connected to the device, it reports temperature readings based on the threshold defined in this parameter. This parameter only applies to the Celsius temperature unit (the Fahrenheit unit is currently not supported).

Values (size is 1 byte dec):

- Default value 5 = 0.5 °C
- 0 – Reporting disabled
1 - 127 = Where 1 stands for 0.1°C and 127 stands for 12.7 °C

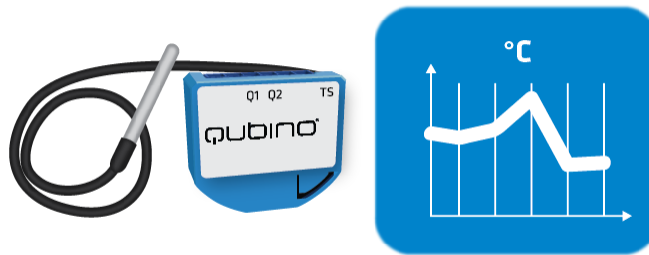





14. Technical Specifications

Power supply	110 - 240 VAC \pm 10% 50/60Hz, (24-30VDC)
Rated load current of AC/DC output (resistive load)*	2 X 4A / 240VAC / 30VDC
Output circuit power of AC/DC output (resistive load)	2 X 920W (240VAC) / 2 X 96W (24VDC)
Power measurement accuracy	P=0-200W, \pm 2W P>200W, \pm 3%
Digital temperature sensor range	-50 ~ +125°C (-58 ~ 257°F)
Operation temperature	-10 ~ +40°C (14 ~ 104°F)
Z-Wave operation range	up to 30 m indoors (98 ft)
Dimensions (WxHxD) (package)	41,8x36,8x16,9 mm (79x52x22 mm) / 1,65x1,45x0,66 in (3,11x2,05x0,87 in)
Weight (with package)	28g (34g) / 0.98oz (1.20oz)
Electricity consumption	0,4W
For installation in boxes	$\varnothing \geq 60$ mm (2,36 in) or 2M, depth ≥ 60 mm (2,36 in)
Switching	Relay (2x)
Z-Wave Repeater	Yes

* In case of loads other than resistive loads, please pay attention to the value of $\cos \phi$. If necessary, connect loads less powerful than what they're rated for – this applies to all motor loads. Max current for $\cos \phi=0,4$ is 2A at 250VAC, 3A at 24VDC.

Supported loads

	<p>Electric motor</p>	<p>Apply $\cos \varphi$ for calculation of max. Current. Max current for $\cos \varphi=0,4$ is 2 A at 250 VAC. In case of inductive loads it is recommended to use RC snubber circuit.</p>
	<p>Conventional incandescent and halogen lights</p>	
	<p>LED bulb, compact fluorescent bulb (CFL), low voltage halogen bulbs with electronic transformer</p>	<p>LED: 0,5A per channel CFL* LVH Electronic transformer: 2,4A per channel</p>
	<p>Low voltage halogen bulbs with conventional transformer</p>	<p>*</p>
	<p>Other type of loads</p>	<p>*</p>

* Please contact Qubino support regarding marked load types:

<http://qubino.com/support/#email>

15. Z-Wave Command Classes

ZWAVEPLUS_INFO_REPORT_ROLE_TYPE_SLAVE_ALWAYS_ON

GENERIC_TYPE_SWITCH_BINARY

SPECIFIC_TYPE_POWER_SWITCH_BINARY

Supported Z-Wave Command Classes:

COMMAND_CLASS_ZWAVEPLUS_INFO_V2

COMMAND_CLASS_VERSION_V2

COMMAND_CLASS_MANUFACTURER_SPECIFIC_V2

COMMAND_CLASS_DEVICE_RESET_LOCALLY_V1

COMMAND_CLASS_POWERLEVEL_V1

COMMAND_CLASS_BASIC_V1

COMMAND_CLASS_SWITCH_ALL_V1

COMMAND_CLASS_SWITCH_BINARY_V1

COMMAND_CLASS_METER_V4

COMMAND_CLASS_SENSOR_MULTILEVEL_V7

COMMAND_CLASS_MULTI_CHANNEL_V4

COMMAND_CLASS_ASSOCIATION_V2

COMMAND_CLASS_MULTI_CHANNEL_ASSOCIATION_V3

COMMAND_CLASS_ASSOCIATION_GRP_INFO_V2

COMMAND_CLASS_CONFIGURATION_V1

COMMAND_CLASS_MARK

COMMAND_CLASS_BASIC_V1

Endpoint 1 (Wall Switch I1)**Device Class:**

GENERIC_TYPE_SWITCH_BINARY

SPECIFIC_TYPE_POWER_SWITCH_BINARY

Command Classes:

COMMAND_CLASS_ZWAVEPLUS_INFO_V2

COMMAND_CLASS_VERSION_V2

COMMAND_CLASS_SWITCH_BINARY_V1

COMMAND_CLASS_BASIC_V1

COMMAND_CLASS_SWITCH_ALL_V1

COMMAND_CLASS_ASSOCIATION_V2

COMMAND_CLASS_MULTI_CHANNEL_ASSOCIATION_V3

COMMAND_CLASS_ASSOCIATION_GRP_INFO_V2

COMMAND_CLASS_METER_V4

COMMAND_CLASS_MARK

COMMAND_CLASS_BASIC_V1

Endpoint 2 (Wall Switch I2):**Device Class:**

GENERIC_TYPE_SWITCH_BINARY

SPECIFIC_TYPE_POWER_SWITCH_BINARY

Command Classes:

COMMAND_CLASS_ZWAVEPLUS_INFO_V2

COMMAND_CLASS_VERSION_V2

COMMAND_CLASS_SWITCH_BINARY_V1

COMMAND_CLASS_BASIC_V1

COMMAND_CLASS_SWITCH_ALL_V1

COMMAND_CLASS_ASSOCIATION_V2

COMMAND_CLASS_MULTI_CHANNEL_ASSOCIATION_V3

COMMAND_CLASS_ASSOCIATION_GRP_INFO_V2

COMMAND_CLASS_METER_V4

COMMAND_CLASS_MARK

COMMAND_CLASS_BASIC_V1

Endpoint 3 (External Temperature Sensor):

Device Class:

GENERIC_TYPE_SENSOR_MULTILEVEL

SPECIFIC_TYPE_ROUTING_SENSOR_MULTILEVEL

Command Classes:

COMMAND_CLASS_ZWAVEPLUS_INFO_V2

COMMAND_CLASS_VERSION_V2

COMMAND_CLASS_SENSOR_MULTILEVEL_V7

COMMAND_CLASS_ASSOCIATION_V2

COMMAND_CLASS_MULTI_CHANNEL_ASSOCIATION_V3

COMMAND_CLASS_ASSOCIATION_GRP_INFO_V2

NOTE: The Endpoint 3 command class list only applies if an external digital temperature sensor (sold separately) is connected to the TS terminal. If the sensor is not connected, the following command class is not supported by the device:

COMMAND_CLASS_SENSOR_MULTILEVEL_V7

This product can be included and operated in any Z-Wave network with other Z-Wave certified devices from any other manufacturers. All constantly powered nodes in the same network will act as repeaters regardless of the vendor in order to increase reliability of the network.

COMMAND_CLASS_METER

- Default values:
 - Rate Type = 1 (Import)
 - Scale = 0 (kWh)

16. Important Disclaimer

Z-Wave wireless communication is not always 100% reliable. This device should not be used in situations in which life and/or valuables are solely dependent on its functioning. If the device is not recognized by your gateway (hub) or shows up incorrectly, you may need to change the device type manually and make sure your gateway (hub) supports multi-channel devices. Contact us for help before returning the device: <http://qubino.com/support/#email>

17. Warning

Do not dispose of electrical appliances as unsorted municipal waste, use separate collection facilities. Contact your local government for information regarding the collection systems available. If electrical appliances are disposed of in landfills or dumps, hazardous substances can leak into the groundwater and get into the food chain, damaging your health and well-being. When replacing old appliances with new ones, the retailer is legally obligated to take back your old appliance for disposal free of charge.

18. Regulations

FCC COMPLIANCE STATEMENT:

This device complies with part 15 of the FCC Rules. Operation is subject to the following two conditions: (1) This device may not cause harmful interference, and (2) this device must accept any interference received, including interference that may cause undesired operation NOTE: This equipment has been tested and found to comply with the limits for a Class B digital device, pursuant to part 15 of the FCC Rules. These limits are designed to provide reasonable protection against harmful interference in a residential installation. This equipment generates, uses and can radiate radio frequency energy and, if not in-stalled and used in accordance with the instructions, may cause harmful interference to radio communications. However, there is no guarantee that interference will not occur in a particular installation. If this equipment does cause harmful interference to radio or television reception, which can be determined by turning the equipment off and on, the user is encouraged to try to correct the interference by one or more of the following measures: —Reorient or relocate the receiving antenna. — Increase the separation between the equipment and receiver. —Connect the equipment into an outlet on a circuit different from that to which the receiver is connected. —Consult the dealer or an experienced radio/ TV technician for help.

Legal Notice

This user manual is subject to change and improvement without notice. GOAP d.o.o. Nova Gorica reserves all rights to revise and update all documentation without any obligation to notify any individual or entity.

Declaration of Conformity

Qubino Flush 2 Relay device is in compliance with the essential requirements and other relevant provisions of the Low voltage (LVD) Directive (2014/35/EU), Electromagnetic Compatibility (EMC) Directive (2014/30/EU), Radio Equipment Directive (2014/53/EU), Directive RoHS 2 (2011/65/EU) and Directive ErP (2009/125/EC).

WEEE

According to the WEEE (Waste electrical and electronic equipment) Directive, do not dispose of this product as household waste or commercial waste. Waste electrical and electronic equipment should be appropriately collected and recycled as required by practices established for your country. For information on recycling of this product, please contact your local authorities, your household waste disposal service or the shop where you purchased the product.

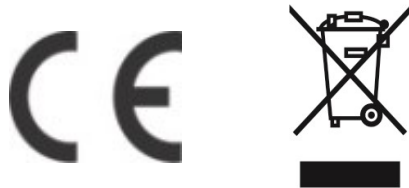

NOTE: User manual is valid for device with SW version S5 (SW version is part of P/N)!

Example: P/N: ZMNHBDx HxS5Px

Goap d.o.o. Nova Gorica

Ulica Klementa Juga 007, 5250 Solkan, Slovenia

E-mail: info@qubino.com

Tel: +386 5 335 95 00

Web: www.qubino.com

Date: 10.8.2018; V 2.3

[DON'T MISS OTHER INVENTIONS FROM QUBINO– CLICK HERE AND CHECK OUT QUBINO'S COMPLETE PORTFOLIO](#)